



Andres Industries AG

protection for action

Not just a Waterproof Case but a System Solution



for Microsoft and
Apple tablets

IP67

waterproof and dust-proof, fully submersible 0.5h at 1m depth

MIL 810G

withstands 26 drops from 1.22m onto concrete according to US MIL-STD-810G



waterproof loading

Shell Cases

The comprehensive system solution for Microsoft Surface Go and Apple iPads

Shell is not just a product line of waterproof cases, it is a smart system solution for the Microsoft Surface Go and Apple iPads. The waterproof and shock-resistant housings were specifically designed for industrial use and are therefore extremely robust. They are compatible with the well-established RAM-Mount-System. Consequently, they can be mounted

anywhere. When equipped with the unique Car Cradle Connector they remain waterproof, while they are continuously being charged in the Car Cradle. Even in this configuration they still can be removed within seconds. This is especially appreciated by delivery drivers, rescue workers and all other professionals for whom time is of the essence. Right from

the start we designed Shell as a system solution. They are therefore extremely expandable and convertible. There is no other housing system in the world offering such possibilities. However, if additional features are needed, we are at your service to develop tailor-made solutions.

Cutout for front camera and light sensors



Enclosed by high quality protective screen. Touch screen remains fully usable.

All 3 buttons fully functional

IP67

MIL 810G



Fig. illustrates aiShell 11™

Colors, logos and customized housings

The Shell system is manufactured at our headquarters in Berlin. Therefore, we can change any detail according to your needs. We can produce cases in special colors starting from 200 units without extra charge. Logo prints for order volumes of 50 units and more are free of charge too. The interfaces on the back and at the sides of the case offer almost endless possibilities. Depending on the needs of your profession we can develop special brackets or connectors, so that your version of aiShell™ or GoShell™ will fit your specific application perfectly.



Off-the-shelf colors

Backside

Many possibilities to interface

On the back of our Shell cases, the possibilities for expansion and adaptation become clear: These have been continuously improved during the development of the aiShell™ product series and have proven themselves in many years of practical use. This means that you can benefit from a wide range of accessories right from the market launch of a new

Shell case. All accessories are suitable for both the industrial and other professional use as well as for private applications. If the materials are not suitable for your specific purpose, they can be replaced (e.g. we can incorporate high-performance polymers that can withstand high temperatures and/or aggressive solvents). For the interfaces on the back of the

Shell we can develop accessories to meet a wide range of customer specific requirements and thus avoid the costly development of specific enclosures.



Shell models

aiShell mini+™

Suitable for Apple iPad mini 4, lockable with special screws to protect against unauthorized opening, front and rear camera window, waterproof charging plug, aiShell™ Car Cradle or Rack-10 available as accessories.

aiShell mini 5™

Like aiShell mini+™ but suitable for Apple iPad mini 5th Gen..

aiShell 9.7™

Suitable for Apple iPad Air 2, iPad Pro 9.7", iPad 2017 (5th Gen.) and iPad 2018 (6th Gen.).

aiShell 10™

Like aiShell 9.7™ but suitable for Apple iPad 10.5", 10.2" and iPad Air 3. Gen..

aiShell 11™

Like aiShell 10™, but suitable for Apple iPad Pro 11" (1st, 2nd and 3rd Gen.) and iPad Air 10.9" (4th Gen.).

aiShell 12.9™

Like aiShell mini+™ but suitable for Apple iPad 12.9" 1. and 2. Gen..

GoShell 10™

Suitable for Microsoft Surface Go and Surface Go 2, lockable with special screws to prevent unauthorized opening, front and rear camera window.

For more information on colors, part numbers and accessories, please refer to pages 8 and 9.

Shell concept

Shell cases are waterproof and shock resistant. There is no other system solution for Microsoft Surface Go or Apple iPads which offers such expandability. The standard scope

of delivery of Shell satisfies the needs of private users. Professionals tend to adapt their Shell with suitable accessories. These are available for almost every possible application. If you

are facing extraordinary tasks, we can develop and produce custom-made solutions with special materials and/or tailored features for you.

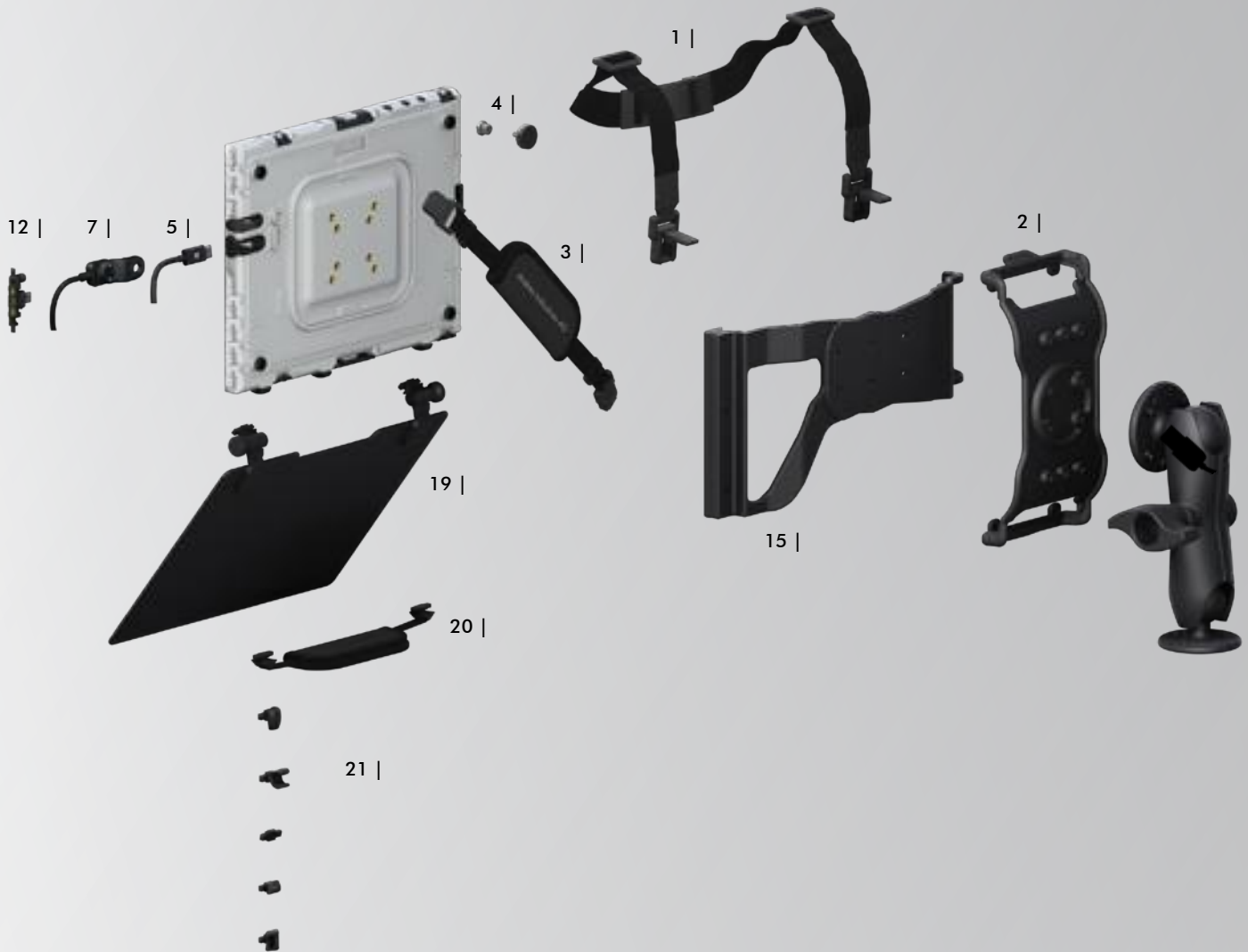

Accessories for backside

1 | Shell Shoulderstrap

On the backside of Shell an easily removable Shoulderstrap can be attached in various positions. If necessary, 2 Shoulderstraps can be combined. Shell can thus be worn like a hawker's tray. **No. 291015**

2 | Quicksnapper

If you want Shell to be securely mounted while being easily removable, the Quicksnapper is our reliable solution. The Quicksnapper can be screwed directly to a table or a wall. Alternatively, it can be fixed to a RAM-Mount (see pages 10-11).

Quicksnapper 9.7

for aiShell 9.7, Air™

No. 280010

Quicksnapper 10

for GoShell 10™ and aiShell 10™

No. 295011

Quicksnapper mini

for aiShell mini, mini+, mini 5™ | not illustrated

No. 291020

Quicksnapper 11

for aiShell 11™ | not illustrated

No. 298520

Quicksnapper 12.9

for aiShell 12.9™ | not illustrated

No. 291120

3 | Shell Handstrap back

This length-adjustable strap with its 2 attachment points can be connected to each of the 4 Sprue Nuts. It can thus be used either alone or in combination with the Shoulderstrap. You can remove it quickly and easily in the same way as the Shoulderstrap. **No. 293007**

4 | Magnetic Feet (Set of 4)

We have developed Magnetic Feet to widen the scope of applications for Shell. After removing the standard Rubber Feet, the Magnetic Feet can be mounted on the back. They are strong enough to securely attach Shell to ferromagnetic surfaces. **No. 293009**



Charging options

5 | Standard Connector

A USB-C standard charging cable is part of the standard scope of delivery. With such a cable it is possible to synchronize and charge your Microsoft Surface Go in the GoShell™. No. 350117 (colors black or white)



6 | Standard (Lightning Connector)

The original charging cable for iPads can be used for charging process (not included). During the process of charging the system is not waterproof. Only after removing the connector and sealing the case with a plug it is waterproof again. For daily charging this process is viable.



7 | Shell-USB-C Waterproof Connector

Shell-USB-C waterproof connector is waterproof and can be attached without the use of tools. It comes with a 1m cable and a standard USB-C 3.1 connector. This accessory is not compatible with older iPad models that charge via a Lightning connector.

for GoShell 10 and aiShell 11 No. 298510



8 | aiShell™ Charging Connector

If the iPad has to be charged waterproof in the case, this Charging connector can be used. The Charging Connector will be screwed onto the case and contains an USB plug by which you can connect Apple adapters with. You don't need any extra tools. The solution is often used by sailors because you only need to adjust the connector once a day.

The USB plug at the end of the cable is not waterproof.

with 1m cable No. 291035
with 2m cable No. 291036



9 | CPS-Lighter 15,5W

The CPS-lighter (car power supply), a universal car and truck charging adapter (5V/3.1A 15.5W) for charging and operating devices with USB compatible power supply. The adapter fits into the standard connection of the cigarette lighter in the car or truck. The charging function can be controlled via the built-in LED. For safety, the adapter has a built-in surge protector.

CPS-Lighter 15.5W No. 294022
CPS-Lighter USB-C/A No. 298512



10 | Rack-10

In Rack-10, up to 10 devices in the Shell can be charged simultaneously via the Car Cradle Connector. It is suitable for all standard server racks. Up to 2 racks can be installed on 1 floor due to the low installation depth of only 250mm. Therefore, large cabinets can accommodate up to a total of 100 charging bays. If desired, individual racks can be delivered as pull-out drawers. This facilitates inserting and removing. The Rack has an integrated power supply unit that allows to charge every device with up to 2A.

aiRack-10 for aiShell 10, 9.7, Air, mini, mini+, mini5
No. 299090
USB-Rack-10 for aiShell 11 and GoShell 10
No. 299093 (available from end 2021)



11 | CPS-Direct

The CPS-Direct (car power supply), a flat power USB socket (12-24V DC / 5V DC 3000mA) with integrated voltage converter suitable for the connection to the 12-24V wiring system of cars, trucks, buses, caravans and boats and is suitable for charging and operating smartphones, navigation devices, digital cameras, mobile phones, MP3 players, e-readers, photo cameras, all kinds of tablets, as well as other electronic devices that can be charged via USB and need a high charging current. We tested it and recommend it for charging the iPad in the Car Cradle.

CPS-Direct No. 294021
CPS-Direct Power USB-C/A No. 298511





Car Cradle – charging and mounting merged

The solution is especially made for delivery drivers who need to plug and unplug the case several times a day. If the Shell is equipped with the Car Cradle Connector it can be simultaneously charged in the Car Cradle. With this solution the case does not have to be opened and stays waterproof under any circumstance.

12 | Car Cradle Connector

After removing the waterproof plugs included in the scope of delivery, the Car Cradle Connector can be attached (no tools required). During use, your device can be charged in the waterproof Shell with the Car Cradle or in the Rack-10. This opens many applications for devices in industry, transport and other sectors. While the connector is attached, your device can be charged in the Car Cradle or the Rack-10. With the Car Cradle Connector in place synchronizing by USB and using the headphone jack is no longer possible.

for GoShell™ I not illustrated **No. 350126**
for aiShell 10, 9.7, Air, mini, mini+ und mini 5™
No. 291077



13 | aiShell™ Car Cradle Connector - USB-C
The aiShell™ Car Cradle Connector is waterproof and can be attached without the use of tools. It is equipped with a standard USB-C 3.1 connector. Not compatible with older iPad models.

for aiShell 11™ I not illustrated
No. 298530

14 | aiShell™ Charging Clip

The Charging Clip is the smaller alternative to the Car Cradle and makes it possible to charge the device in the aiShell™ via Car Cradle connector.

for aiShell 12.9, 10, 9.7, Air and mini™
No. 291032

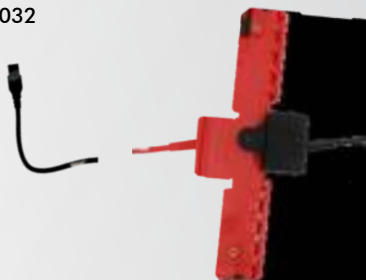

The Car Cradle is especially useful for drivers who need to plug and unplug their device frequently during the day. If Shell is equipped with the Car Cradle Connector [12] it can be automatically charged in the Car Cradle. With this solution the case does not have to be opened and consequently always stays waterproof. Like the Quicksnapper, the Car Cradle can either be screwed directly to walls/tables or it can be mounted with a RAM-202 or many other RAM-Mounts (see page 10). RAM-Mounts are not included in the standard scope of delivery.

15 | Car Cradle

for aiShell 12.9™
1m **No. 291085**
1.8m **No. 291084**
3m **No. 291088**

for aiShell 11™
1m **No. 298531**
1.8m **No. 298532**
3m **No. 298533**

for aiShell 10, Air, 9.7, mini, mini+ and mini 5™
1m **No. 291094**
1.8m **No. 291096**
3m **No. 291098**

for GoShell™
1m **No. 350120**
1.8m **No. 350122**
3m **No. 350124**



Image similar

16 | Car Cradle incl. Connector

Same as item 15 but including Car Cradle Connector
for aiShell 12.9™
1m **No. 291086**
1.8m **No. 291087**
3m **No. 291089**

for aiShell 11™
1m **No. 298534**
1.8m **No. 298535**
3m **No. 298536**

for aiShell 10, Air, 9.7, mini, mini+ and mini 5™
1m **No. 291095**
1.8m **No. 291097**
3m **No. 291099**

for GoShell 10™
1m **No. 350121**
1.8m **No. 350123**
3m **No. 350125**

17 | Car Cradle Connector Ultra Rugged

The robust docking connector has two gold-plated contacts that enable the charging function. The connector is fixed directly to the aiShell™ by means of screws and can only be used in conjunction with the aiShell™ Car Cradle Ultra Rugged or the Rack.

for aiShell 10, 9.7, Air, mini, mini+ and mini 5™ I not illustrated
No. 291075

18 | Car Cradle Ultra Rugged

In the past, extremely strong vibrations, e.g. when used in mining or in unsprung vehicles, led to a reduced charging current. For these extreme requirements we have now developed the Ultra Rugged series. Even with strong vibrations it delivers a charging current of 2A and thus ensures the charging of the iPad during operation. Existing iPads can be retrofitted with the Ultra Rugged System. Both the Car Cradle and the Connector are exchanged. Since the new system works with an increased charging voltage of 9V, older systems could be damaged if they are operated in an Ultra Rugged Car Cradle. Therefore we recommend to always renew all existing systems at the same time to avoid confusion.

for aiShell 10, 9.7, Air, mini, mini+ and mini 5™
I not illustrated
1m **No. 291131**
1.8m **No. 291133**
3m **No. 291135**

Lateral accessories

With the lateral accessories, Shell Cases can be accessorized in a total of 7 positions. A Pen Holder, a Rubber Feet or a Blind Plug can be attached to each of these positions. When purchasing a Shell 2 Pen Holders, 3 Rubber Feet and 7 Blind Plugs are already included in the standard scope of delivery. No tools are required for the installation. Special plugs can also be developed on request which fit these 7 positions.



Open the Shell



Insert the side accessory in one of the seven possible positions

19 | Sunshade

Another lateral accessory is the Sunshade. Closed it serves as display protection. As it can be adjusted to any angle, it also serves as sunshade and as table stand. It can also be locked in place by turning two rotating knobs.

for GoShell10™ No. 350116

for aiShell 11™ I not illustrated No. 298540

for aiShell 10™ I not illustrated No. 291019

for aiShell 9.7™ I not illustrated No. 291018



Display Cover

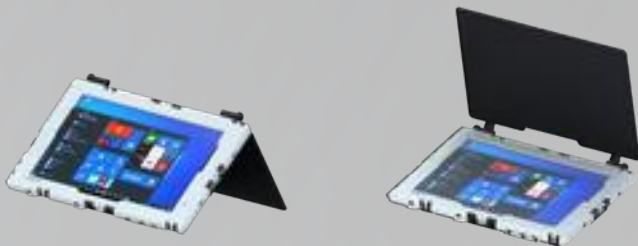

Desk Stand

Sunshade

20 | Shell handstrap side

The new length-adjustable Side Handstrap allows even more ergonomic use of a Shell. It can be combined with other lateral accessories.

No. 290348



21 | Shell Lateral Accessories Kit

The set of spare parts includes the following lateral accessories: 3 Rubber Feet, 2 Pen Holders, 1 Blind Plug, 1 Spring Hook Eyelet and 2 Handstrap Buckles.

for GoShell™ No. 350114

for aiShell 9.7, 10 and 11™ I not illustrated No. 290071



Spring Hook Eyelet



Blind Plug



Handstrap Buckle



Rubber Foot



Pen Holder

Accessories for the front

22 | aiShell™ mini Displaycover

The Displaycover is an additional protection. If the Displaycover is not needed to protect the screen it can be snapped on the back of the case to avoid losing it. available for aiShell mini, mini, mini5™ No. 291030



You want to stay up to date?

If you want to learn more about our company and our Shell products, why not follow us on one of our social media channels?

IG: @andresindustriesag_berlin

FB: @andresindustries

WEB: www.andres-industries.de



Of course you can also subscribe to our newsletter at andres-industries.de - the classic way. Are you interested in our dealer newsletter? Then simply get in touch with our sales department!

Shell	aiShell mini+™	aiShell mini 5™	aiShell 9.7™
suitable for	iPad mini 4	iPad mini 5 (2019)	iPad Air 2
	iPad mini 2019 (5. Gen.)		iPad Pro 9.7" iPad 2017 (5. Gen.) iPad 2018 (6. Gen.)
	A1538, A1550, A2124, A2125, A2126, A2133	A2124, A2125, A2126, A2133	A1566, A1567, A1673, A1674, A1675, A1822, A1823, A1893, A1954, A1474, A1475, A1476
waterproof/shock resistant	IP67 (waterproof up to 1m) / MIL-STD-810G 4.6.5 Procedure IV - Transit Drop (military grade)		
dimensions (mm)	222×159×22	222×159×22	256×192×22
weight (g)	235	235	315
case material	ABS Plastic		
matte foil	optional	optional	optional
standard foil	optional	optional	optional
hybrid glass	optional	optional	optional
black	294000	297000	281001
white	294001	297001	281002
blue	294003	297003	281004
yellow	294004	297004	281005
red	294006	297006	–
olive green	–	297002	281003
coyote	On request		
	Included in delivery		
	–		Penholder Blindplugs Standing Foot
	–		
	–		
	Optional accessories		
RAM - B/C - 202U	optional	optional	optional
aiShell™ Car Cradle	optional	optional	optional
aiShell™ Car Cradle mini	optional	optional	–
GoShell™ Car Cradle	–	–	–
GoShell™ Car Cradle Connector	–	–	–
aiShell™ Car Cradle Connector	optional	optional	optional
aiShell™ Car Cradle Connector – USB-C	–	–	–
aiShell™ Car Cradle Connector mini	optional	optional	–
aiShell™ Car Cradle - USB-C	–	–	–
CPS–direct	optional	optional	optional
CPS–direct - USB-C	optional	optional	optional
CPS–lighter 15.5 W	optional	optional	optional
CPS–lighter 15.5 W - USB-C	optional	optional	optional
aiRack–10	optional	optional	optional
USB-Rack–10 (from end of 2021)	–	–	–
Quicksnapper mini	optional	optional	–
Quicksnapper 9.7	–	–	optional
Quicksnapper 10	–	–	–
Quicksnapper 12.9	–	–	–
Quicksnapper 11	–	–	–
aiShell™ Charging Connector	optional	optional	optional
Shell-USB-C Waterproof Connector	–	–	–
Shell Shoulderstrap	optional	optional	optional
Shell Shoulderstrap incl. emergency opening	optional	optional	optional
Shell Handstrap back	optional	optional	optional
Shell Handstrap side	–	–	optional
aiShell™ mini Displaycover	optional	optional	–
aiShell™ Sunshade 11	–	–	–
aiShell™ Sunshade 10	–	–	–
aiShell™ Sunshade 9.7	–	–	optional
GoShell™ Sunshade	–	–	–
Magnetic Feet Set	optional	optional	optional
aiShell™ Charging Clip	–	–	optional
GoShell™ Accessory Kit	–	–	–
aiShell™ Accessory Kit	–	–	optional
	The article numbers in the table refer to the standard version with glossy display film. If desired, this can be replaced with a matte foil or hybrid glass foil. To do this, add the suffix "-m" (matte foil) or a "-g" (hybrid glass) to the desired item number.		

aiShell 10™	aiShell 12.9™	aiShell 11™	GoShell 10™
iPad Pro 10.5"		iPad Pro 11" (1., 2. and 3. Gen.)	Microsoft Surface Go
iPad Air 2019 (3. Gen.)	iPad Pro 12.9" (1. and 2. Gen.)		
iPad 10.2" 2019 (7. Gen.)		iPad Air 10.9" (4. Gen.)	Surface Go 2
iPad 2020 (8. Gen.)			
A1701, A1709, A2152, A2123, A2153, A2154, A2197, A2200, A2198, A2270, A2428, A2429, A2430	A1670, A1671, A1584, A1652	A2228, A2068, A2230, A2231, A1980, A2013, A1934, A1979, A2316, A2324, A2325, A2072, A2301, A2459, A2460	
IP67 (waterproof up to 1m) / MIL-STD-810G 4.6.5 Procedure IV - Transit Drop (military grade)			
276×199×21	330×245×22	277×203×21,2	272×198×22
342	466	332	348
ABS Plastic			
optional	optional	-	-
optional	optional	optional	-
optional	-	optional	optional
298000	-	298500	350101
298001	291101	298501	350102
298003	-	298504	350104
298004	-	298503	350105
298005	291105	298502	350106
-	-	298505	350103
On request			
Included in delivery			
Penholder Blindplugs Standing Foot	-		Penholder Blindplugs Standing Foot
	-		
	-		
Optional accessories			
optional	optional	optional	optional
optional	optional	-	-
-	-	-	-
-	-	-	optional
-	-	-	optional
optional	optional	-	-
-	-	optional	-
-	-	-	-
-	-	optional	-
optional	optional	-	-
optional	optional	optional	optional
optional	optional	-	-
optional	optional	optional	optional
optional	-	-	-
-	-	optional	optional
-	-	-	-
-	-	-	-
optional	-	-	optional
-	optional	-	-
-	-	optional	-
optional	optional	-	-
optional	optional	-	-
optional	optional	-	-
optional	optional	optional	optional
optional	optional	optional	optional
optional	optional	optional	optional
optional	-	optional	optional
-	-	-	-
-	-	optional	-
optional	-	-	-
-	-	-	-
-	-	-	optional
optional	optional	optional	optional
optional	optional	optional	-
-	-	-	optional
optional	optional		-

The article numbers in the table refer to the standard version with glossy display film. If desired, this can be replaced with a matte foil or hybrid glass foil. To do this, add the suffix "-m" (matte foil) or a "-g" (hybrid glass) to the desired item number.

The RAM-Mount-Principle

Mount everything to anything

With the modular RAM-Mount-System you can attach everything on anything. By combining different units, you can create the perfect mounting solution for your needs. The pictures below only show a few examples. In general, RAM-Mount consists of the following components which can be combined freely. RAM-Mounts are available in different sizes. For Shell we

recommend units with C-Ball but in particularly harsh environments (e.g. if strong vibrations are present) D-Ball mounts might be necessary. We are happy to support you in finding the best solution for your application.



Mounting adapter for shell cases:
e.g. Quicksnapper

Upper Base:
e.g. RAM-202, can be screwed on directly

Mid Base:
e.g. RAM-201,
available in various lengths

Lower Base:
e.g. RAM-202,
there are many different units e.g. to
connect with pipes.

Suction foot unit:
e.g. RAM-224-3 in
combination with RAM-202



No-Drill Vehicle Mounts

Vehicle Mounts not requiring drilling

The units portrayed below are perfectly suitable to mount the Shell in a vehicle without drilling. This is done by using attachment points that are already available in the vehicle (e.g. the fixture of the passenger seat). There are plenty of possibilities to mount these units in vehicles.



tripod vehicle-mount:

RAM-316-3-202U
629–807mm
No. 498805



robust vehicle-mount:

RAM-316-HD-18-202U
629–807mm
No. 8900787



simple vehicle-mount:

RAM-316-2U
457mm
No. 498808

RAM-316-HD-202
476–654mm
No. 404745

RAM-316-1-24-202
610mm
No. 498806



Overview C-Ball-RAM-Units

Connection possibilities on Shell backside



RAM-201-D
long connection
piece
No. 303305



RAM-201
medium connec-
tion piece
No. 303405



RAM-201-B
short connection
piece
No. 303205

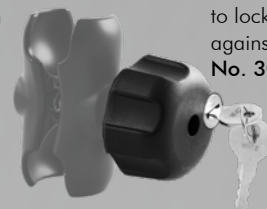

RAM-KNOB5L
to lock units
against theft.
No. 303406

various RAM-Mount-Bases

RAM-231-1
25,4–31,8mm
pipe diameter
No. 404514



RAM-108BU
25,4–53,3mm
pipe diameter
No. 404805



RAM-235
19,0–31,8mm
pipe diameter
No. 405200



RAM-231
12,7–25,4mm
pipe diameter
No. 404513



RAM-271-12
31,8–47,6mm
pipe diameter
No. 303242



RAM-271-2
50,8–63,5mm
pipe diameter
No. 303385

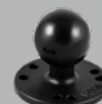

RAM-202
No. 303304



RAM-238U
No. 404904



RAM-224-3
Triple suction cup base
with RAM-202
No. 404511



RAM-118B
102–152mm
pipe diameter
No. 303127



RAM-224U
Suction cup base
with RAM-238
No. 303173

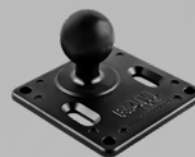

RAM-2461
Vesa Platte
No. 303398



RAM-247
25–63,5mm
pipe diameter
No. 480052

The RAM-202

The RAM-202 can be mounted on the Shell itself, the Quicksnapper and the Car Cradle and is therefore an important interface to almost the entire RAM-Mount-System.



RAM-202 directly
screwed to the back
of the Shell™

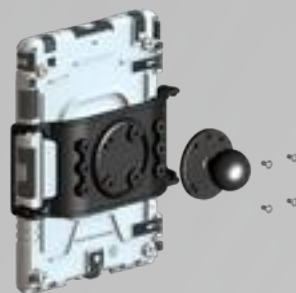

RAM-202 screwed
at Quicksnapper



Screwed to Car Cradle
(Fig. similar)

Your retailer:

Date of issue 06/15/2021



Andres Industries AG
CEO: Dr. Björn Andres
Weißenseer Weg 37
13055 Berlin/Germany

Tel.: +49 (0) 30 45 80 39 00
E-Mail: info@andres-industries.de
www.andres-industries.de

The protected trademarks
are used exclusively for the
description of functions and
procedures.

Follow us on:

