



Product overview 2020

More Space System

MOVUS[®]



Company headquarters

Novus Dahle GmbH
Breslauer Strasse 34-38
49808 Lingen
Germany

Tel. +49 (0) 591/9140-0
Fax +49 (0) 591/9140-841

www.novus.de
info@novus-dahle.com

Content

More space sets

04 - 13

Flat screen holders

Novus MY | Novus Tetra-Support-System | Novus SlatWall | Novus Clu
Novus LiftTEC® | Novus ScreenMount | Novus Tablet holder and accessories

14 - 97

Luminaires

Novus Attenzia luminaires

98 - 109

Office organisation

Universal support arms | Tray sets | Storage boards
Display pocket holder | Additional mounts

110 - 125

Seating ball

126 - 127

Explanation of symbols

128 - 129



Cleverly combined solutions to meet all needs.

Sophisticated combination for
diverse workstation designs.

Customised complete furnishings for more free
space without any compromises.



NOVUS Business Combination

- Optimal set for your notebook workstation
- Classy aluminium finish with anodised surfaces
- Removable clamping grips for protection from theft and cable holder
- Range: TSS folding arm III 505 mm / TSS notebook holder 589 mm
- Mounting standard 75/100 mm
- Column attachment: system clamp 1, clamping length 14-40 mm
- Carrying capacity: monitor weight 7 kg / notebook weight 5 kg, infinitely variable height
- Height of the column: 445 mm

Colours	Art.No.	EAN Code
	220+0070+000	4009729046630

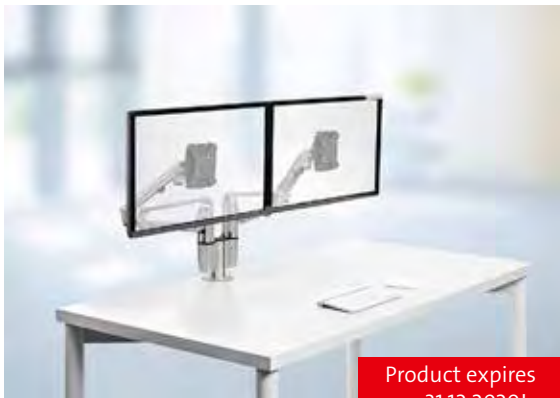

NOVUS Comfort Duo, with drilling screw fitting

- NOVUS LiftTEC: the innovative support arm concept for ergonomics and special convenience
- Range: 547 mm
- Mounting standard 75/100 mm
- Drilling screw fitting, desktop thickness 5-70 mm
- Carrying capacity: monitor weight 2 x 3-8 kg, infinitely variable height
- Height of the column: 120 mm

Colours	Art.No.	EAN Code
	220+0150+000	4009729046715

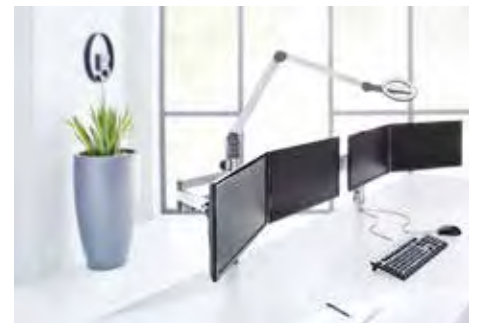



NOVUS Control Center

- Everything in view: the monitor bridge of the NOVUS Tetra Support System for 4 flat screens
- Range: TSS folding arm III 505 mm / SlatWall-LM-Arm 0-0-1125 mm
- Mounting standard 75/100 mm
- Table mounting with system clamp 1 for a desktop thickness of 14-40 mm
- Total carrying capacity: 22 kg, evenly spread over all support arms
- Height of the column: 445 mm
- Size SlatWall over the desk: 1200 x 445 mm

Colours	Art.No.	EAN Code
	220+0130+000	4009729046692



NOVUS TSS Single support carriage

- The starter set for the correct ergonomic use of a flat screen at the workstation
- Classy aluminium finish with anodised surfaces
- Removable clamping grips for protection from theft
- Range: TSS Single support carriage 105 mm
- Easy mounting of the monitor by quick release, suitable for mounting standard 75/100
- Table mounting with system clamp 1 for a desktop thickness of 14-40 mm
- Carrying capacity: monitor weight 15 kg, infinitely variable height
- Height of the column: 445 mm

Colours	Art.No.	EAN Code
	220+0230+000	4009729064528



NOVUS TSS Single support arm

- The set for better ergonomics at the workstation
- Classy aluminium finish with anodised surfaces
- Removable clamping grips for protection from theft and cable holder
- Range: TSS support arm 250 mm
- Easy mounting of the monitor by quick release, suitable for mounting standard 75/100
- Table mounting with system clamp 1 for a desktop thickness of 14-40 mm
- Carrying capacity: monitor weight 15 kg, infinitely variable height
- Height of the column: 445 mm

Colours	Art.No.	EAN Code
	220+0240+000	4009729064535



NOVUS TSS Single folding arm II

- The practical set for the correct ergonomic use of a monitor at the workstation
- Classy aluminium finish with anodised surfaces
- Removable clamping grips for protection from theft and cable holder
- Range: TSS folding arm II 450 mm
- Easy mounting of the monitor by quick release, suitable for mounting standard 75/100
- Table mounting with system clamp 1 for a desktop thickness of 14-40 mm
- Carrying capacity: monitor weight 10 kg, infinitely variable height
- Height of the column: 445 mm

Colours	Art.No.	EAN Code
	220+0250+000	4009729064542





NOVUS TSS Basic

- Novus bestseller for ergonomically correct use of the flat screen at your workstation
- Classy aluminium finish with anodised surfaces
- Removable clamping grips for protection from theft and cable holder
- Range: folding arm III 505 mm
- Easy mounting of the monitor by quick release, suitable for mounting standard 75/100
- Table mounting with system clamp 1 for a desktop thickness of 14-40 mm
- Carrying capacity: monitor weight 12 kg, infinitely variable height
- Height of the column: 445 mm

Colours	Art.No.	EAN Code
	220+0050+000	4009729046616



NOVUS TSS Duo folding arm II

- The simple double screen solution of the Tetra Support System
- Classy aluminium finish with anodised surfaces
- Removable clamping grips for protection from theft and cable holder
- Range: TSS folding arm II 450 mm
- Easy mounting of the monitor by quick release, suitable for mounting standard 75/100
- Table mounting with system clamp 1 for a desktop thickness of 14-40 mm
- Total carrying capacity: 10 kg, evenly spread over all support arms, infinitely variable height
- Height of the column: 445 mm

Colours	Art.No.	EAN Code
	220+0270+000	4009729064566



NOVUS TSS Duo Telescope

- The space-saving dual-monitor solution of the NOVUS Tetra Support System for mounting near walls or at two workstations facing each other
- Classy aluminium finish with anodised surfaces
- Removable clamping grips for protection from theft and cable holder
- Range: TSS telescopic arm III 314-400 mm
- Easy mounting of the monitor by quick release, suitable for mounting standard 75/100
- Table mounting with system clamp 1 for a desktop thickness of 14-40 mm
- Total carrying capacity: 11 kg, evenly spread over all support arms, infinitely variable height
- Height of the column: 445 mm



Colours	Art.No.	EAN Code
	220+0260+000	4009729064559



NOVUS TSS Trio Telescope

- The solution for 3 flat screens at a workstation provides even more productivity
- Range: TSS telescopic arm III XL 700 476-724 mm / support carriage 105 mm
- Easy mounting of the monitor by quick release, suitable for mounting standard 75/100
- Drilling screw fitting HD, for desktop thickness 15-70 mm
- Total carrying capacity: 31 kg, evenly spread over all support arms, infinitely variable height
- Height of the column: 445 mm



Colours	Art.No.	EAN Code
	220+0300+000	4009729068908

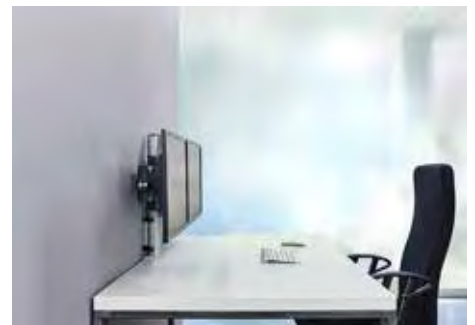
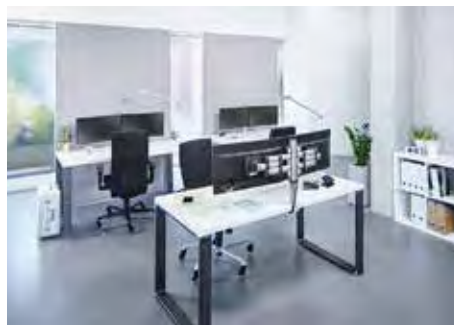



NOVUS TSS Quattro Telescope

- four flat screens, no problem for the NOVUS Tetra-Support-System
- Range: TSS telescopic arm III 314-400 mm
- Easy mounting of the monitor by quick release, suitable for mounting standard 75/100
- Drilling screw fitting HD, for desktop thickness 15-70 mm
- Total carrying capacity: 40 kg, evenly spread over all support arms, infinitely variable height
- Height of the column: 845 mm

Colours	Art.No.	EAN Code
	220+0310+000	4009729068915



NOVUS TSS Sextett Telescope

- six flat screens, no problem for the NOVUS Tetra-Support-System
- Range: TSS telescopic arm III XL 700 476-724 mm / support carriage 105 mm
- Easy mounting of the monitor by quick release, suitable for mounting standard 75/100
- Drilling screw fitting HD, for desktop thickness 15-70 mm
- Total carrying capacity: 48 kg, evenly spread over all support arms, infinitely variable height
- Height of the column: 845 mm

Colours	Art.No.	EAN Code
	220+0320+000	4009729068922





NOVUS TSS Wall Station

- Special applications demand special solutions - the NOVUS Tetra-Support-System for wall mounting.
- Range: TSS support carriage 105 mm / keyboard holder 528 mm
- Mounting standard 75/100 mm
- Carrying capacity: monitor weight 15 kg, infinitely variable height
- Length of the column: 890 mm.

Colours	Art.No.	EAN Code
	220+0100+000	4009729046661



NOVUS MY one plus & Light

- The space-saving combination of flat screen support and lighting
- Combinable with NOVUS MY tab and NOVUS Quick Release
- Range: MY arm 415 mm / Attenzia complete 726 mm
- Mounting standard 75/100 mm
- Table mounting with system clamp 1 for a desktop thickness of 14-40 mm
- Carrying capacity: monitor weight 5 kg, infinitely variable height
- Height of the column: 350 mm
- Extremely high-performance LED luminaire with a luminous flux of max. 1708 lm

Colours	Art.No.	EAN Code
	220+0290+000	4009729068892

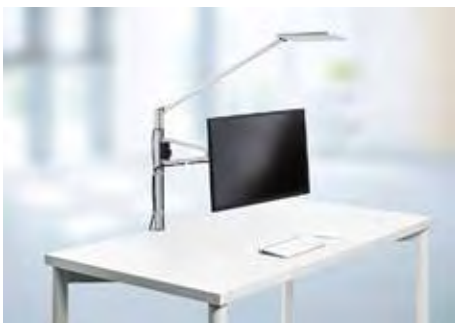



NOVUS Office Toolbar Duo

- 1-part monitor supporting arm with gas spring technology for comfortable, ergonomic adjustment
- Range: Clu I SW 314 mm / Attenzia complete 726 mm
- Easy mounting of the monitor by quick release, suitable for mounting standard 75/100
- Table mounting with system clamp 1 for a desktop thickness of 14-40 mm
- Carrying capacity: Monitor weight 2 x 27 kg, height-adjustable with gas spring technology
- Height of the column: 250 mm
- Extremely high-performance LED luminaire with a luminous flux of max. 1708 lm
- Size MY Toolbar over the desk: 1600 x 250 mm

Colours	Art.No.	EAN Code
	220+0280+000	4009729068885

Individually **combined**
in every **situation.**





Perfect support available everywhere for cutting-edge flat-screen monitors, laptops and tablet PCs – a customised and ergonomic solution.



Enjoy our new **NOVUS MY Series**
with improved functions from
01/04/2020!

Novus MY: solutions for more style and efficiency at the workplace

Novus MY combines form, function and elegance in attractive product solutions with a stylish look. The series includes perfect support arm solutions and holders for monitors, notebooks and tablet PCs. Their flexibility and manoeuvrability mean every workstation can be optimally organised.

Design and efficiency in their purest form

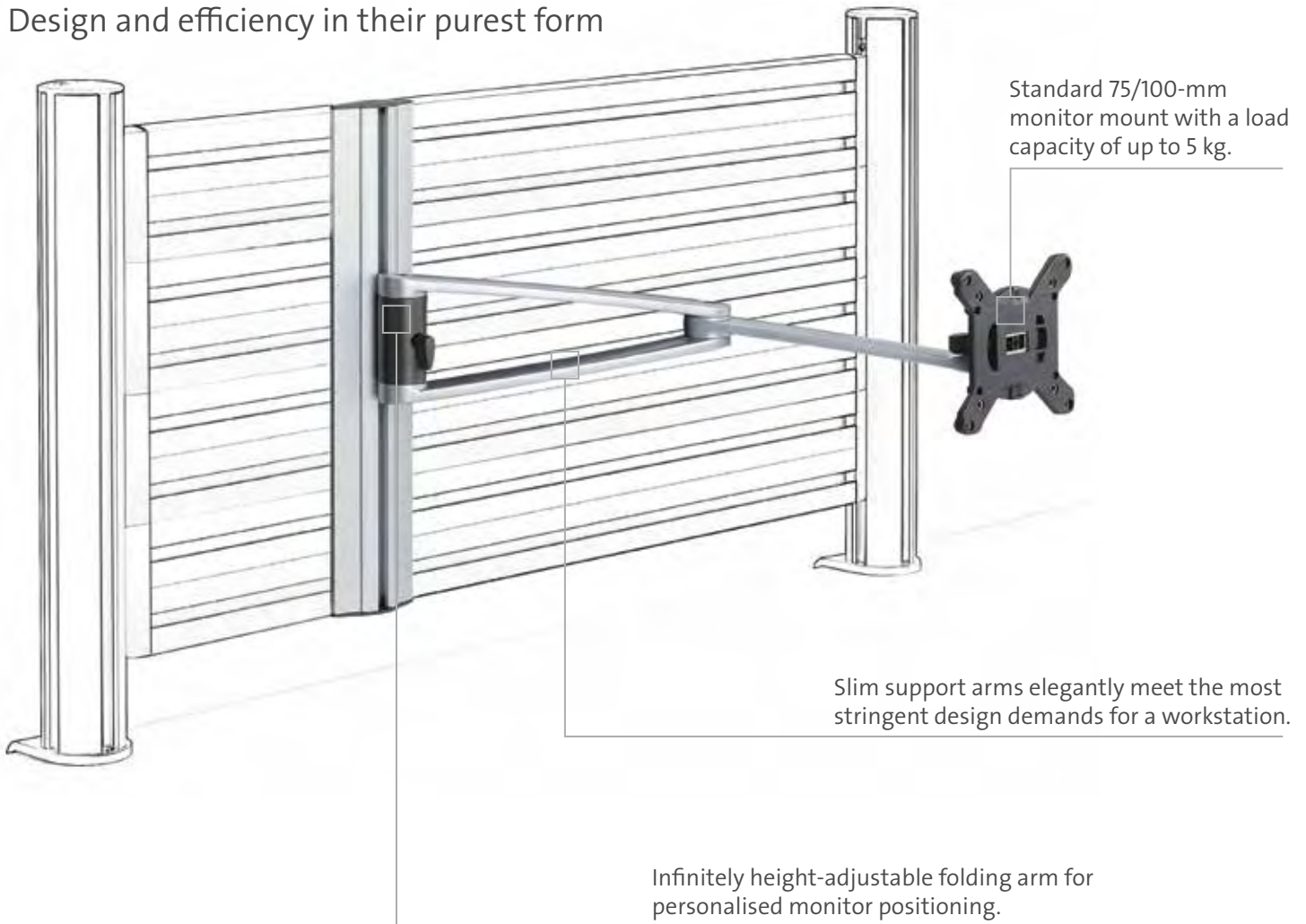

Suitably secured

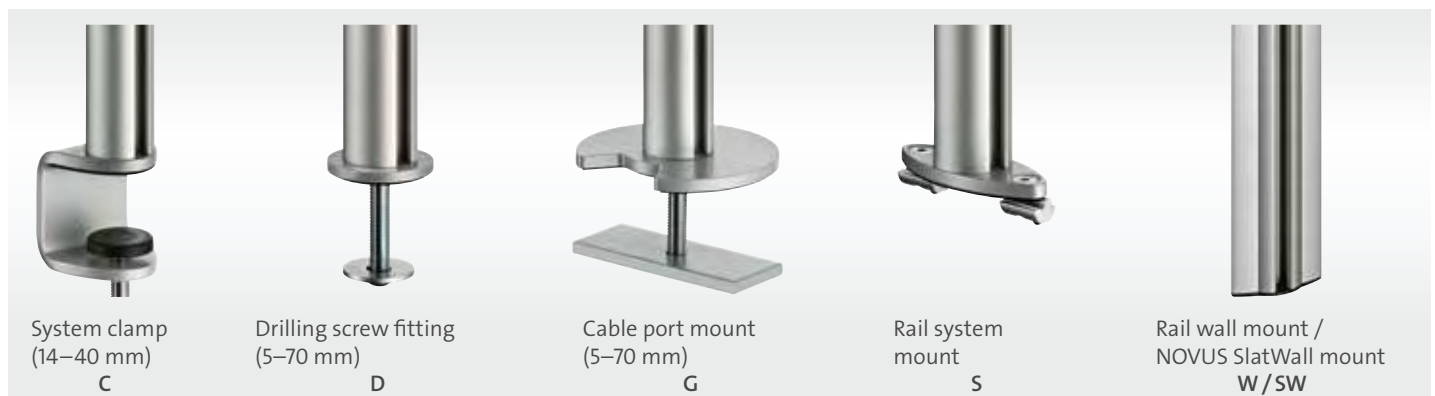

Cleverly combined

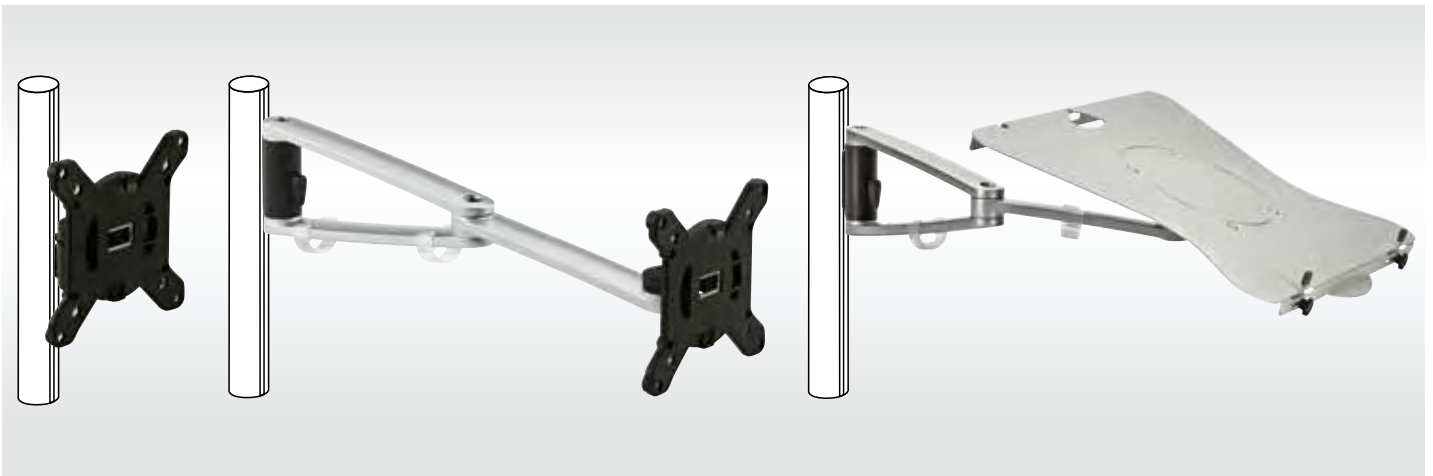

Support carriage / 2-part articulated arm / notebook holder: allows the desired position of the monitor or notebook to be precisely adjusted to the individual user.



Adapter plate allows the monitor to be easily replaced.



Tablet holder for tablets sized 7" to 10".

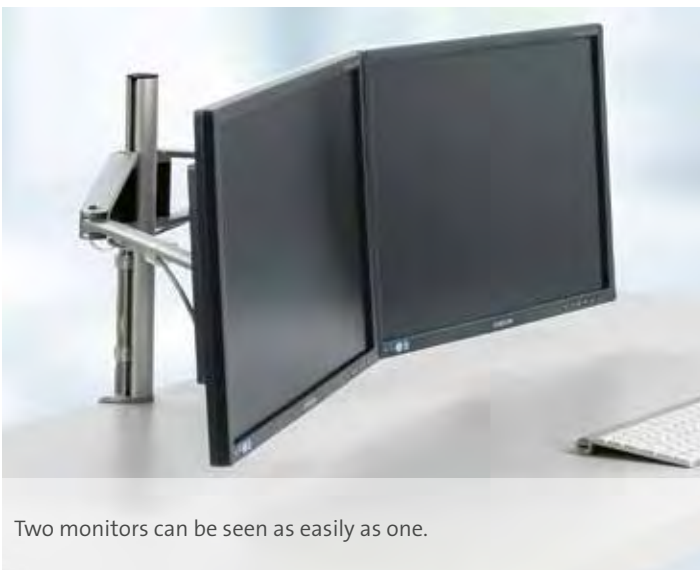

Two monitors can be seen as easily as one.



Connection to an organisation wall possible.

Enjoy our new **NOVUS MY Series**
with improved functions from
01/04/2020!





Product expires
on 31.12.2020!



NOVUS MY point

- Mobile tablet holder as the practical and modern basis for presentation and communication
- Universal stand for Tablets PC's with a size from 7" to 10" (clamping length 160-300 mm)
- Tablets can be used in portrait or landscape format
- Anodised aluminium column with solid metal base
- Rotation and tilt is given by the cross joint for more mobility at limited space
- Infinitely height adjustable
- Height of the column: 250 mm
- Includes two cable clips

Colours	Art.No.	EAN Code
 	910+3099+000	4009729053874



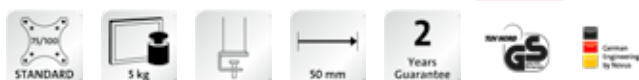

Product expires
on 31.12.2020!



NOVUS MY one C, with system clamp

- Elegant monitor holder with infinitely height adjustable support carriage
- Combination of MY base and MY fix simple, efficient and elegant
- Table mounting with system clamp 1 for a desktop thickness of 14-40 mm
- Mounting standard 75/100 mm
- Mounting of flat screens up to 5 kg
- Rotation and tilt is given by the cross joint for more mobility at limited space
- Range: 50 mm
- Height of the column: 350 mm
- Includes two cable clips
- Combinable with NOVUS MY tab and NOVUS Quick Release

Colours	Art.No.	EAN Code
 	910+1019+000	4009729052099





Product expires
on 31.12.2020!



NOVUS MY one D, with drilling screw fitting

- Elegant monitor holder with infinitely height adjustable support carriage
- Combination of MY base and MY fix simple, efficient and elegant
- Table mount with drilling screw fitting for a table thickness of 5-70 mm
- Mounting standard 75/100 mm
- Mounting of flat screens up to 5 kg
- Rotation and tilt is given by the cross joint for more mobility at limited space
- Range: 50 mm
- Height of the column: 350 mm
- Includes two cable clips
- Combinable with NOVUS MY tab and NOVUS Quick Release

Colours	Art.No.	EAN Code
 	910+1049+000	4009729052105

Flat screen holder Novus MY





Product expires on 31.12.2020!



NOVUS MY one G, with cable port attachment

- Elegant monitor holder with infinitely height adjustable support carriage
- Combination of MY base and MY fix simple, efficient and elegant
- Table mount with drilling screw fitting for a table thickness of 5-70 mm
- Mounting standard 75/100 mm
- Mounting of flat screens up to 5 kg
- Rotation and tilt is given by the cross joint for more mobility at limited space
- Range: 50 mm
- Height of the column: 350 mm
- Includes two cable clips
- Combinable with NOVUS MY tab and NOVUS Quick Release

Colours	Art.No.	EAN Code
 	910+1059+000	4009729052112





Product expires on 31.12.2020!



NOVUS MY one S, with system rail mount

- Elegant monitor holder with infinitely height adjustable support carriage
- Combination of MY base and MY fix simple, efficient and elegant
- System rail mount for use in various system rails of the office furniture industry
- Mounting standard 75/100 mm
- Mounting of flat screens up to 5 kg
- Rotation and tilt is given by the cross joint for more mobility at limited space
- Range: 50 mm
- Height of the column: 350 mm
- Includes two cable clips
- Combinable with NOVUS MY tab and NOVUS Quick Release

Colours	Art.No.	EAN Code
 	910+1069+000	4009729052129

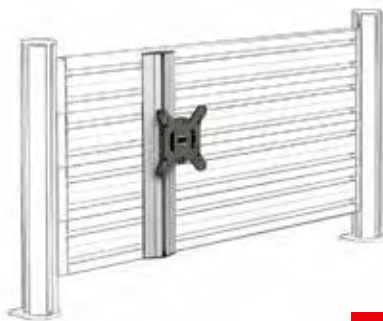



Product expires on 31.12.2020!



NOVUS MY one SW, with organisation wall mount

- Elegant monitor holder with infinitely height adjustable support carriage
- Combination of MY base and MY fix simple, efficient and elegant
- Adaption to the organisation wall via slot nuts
- Mounting standard 75/100 mm
- Mounting of flat screens up to 5 kg
- Rotation and tilt is given by the cross joint for more mobility at limited space
- Range: 50 mm
- Height of the column: 350 mm
- Combinable with NOVUS MY tab and NOVUS Quick Release

Colours	Art.No.	EAN Code
 	910+1079+000	4009729053454

Enjoy our new **NOVUS MY Series**
with improved functions from
01/04/2020!





Product expires
on 31.12.2020!



NOVUS MY one W, with wall mount

- Elegant monitor holder with infinitely height adjustable support carriage
- Combination of MY base and MY fix simple, efficient and elegant
- Wall mounting with screws
- Mounting standard 75/100 mm
- Mounting of flat screens up to 5 kg
- Rotation and tilt is given by the cross joint for more mobility at limited space
- Range: 50 mm
- Height of the column: 350 mm
- Combinable with NOVUS MY tab and NOVUS Quick Release

Colours	Art.No.	EAN Code
 	910+1089+000	4009729053461



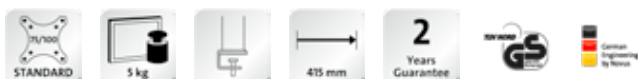

Product expires
on 31.12.2020!



NOVUS MY one plus C, with system clamp

- Elegant monitor holder with infinitely height adjustable folding arm
- Combination of MY base and MY arm for more design, flexibility and dynamics at the workplace
- Table mounting with system clamp 1 for a desktop thickness of 14-40 mm
- Mounting standard 75/100 mm
- Carrying capacity: Monitor weight up to 5 kg
- Range: 415 mm
- Monitor arm infinitely adjustable in height, tilt and rotation
- Height of the column: 350 mm
- Supplied with cable clips
- Combinable with NOVUS MY tab and NOVUS Quick Release

Colours	Art.No.	EAN Code
 	910+2019+000	4009729052051



Flat screen holder Novus MY





Product expires on 31.12.2020!



NOVUS MY one plus D, with drilling screw fitting

- Elegant monitor holder with infinitely height adjustable folding arm
- Combination of MY base and MY arm for more design, flexibility and dynamics at the workplace
- Table mount with drilling screw fitting for a table thickness of 5-70 mm
- Mounting standard 75/100 mm
- Mounting of flat screens up to 5 kg
- Range: 415 mm
- Monitor arm infinitely adjustable in height, tilt and rotation
- Height of the column: 350 mm
- Supplied with cable clips
- Combinable with NOVUS MY tab and NOVUS Quick Release

Colours	Art.No.	EAN Code
 	910+2049+000	4009729052068





Product expires on 31.12.2020!



NOVUS MY one plus G, with cable port attachment

- Elegant monitor holder with infinitely height adjustable folding arm
- Combination of MY base and MY arm for more design, flexibility and dynamics at the workplace
- Table mount with cable port attachment for a table thickness of 5-70 mm
- Mounting standard 75/100 mm
- Mounting of flat screens up to 5 kg
- Range: 415 mm
- Monitor arm infinitely adjustable in height, tilt and rotation
- Height of the column: 350 mm
- Supplied with cable clips
- Combinable with NOVUS MY tab and NOVUS Quick Release

Colours	Art.No.	EAN Code
 	910+2059+000	4009729052075



Enjoy our new **NOVUS MY Series**
with improved functions from
01/04/2020!





Product expires
on 31.12.2020!



NOVUS MY one plus S, with system rail mount

- Elegant monitor holder with infinitely height adjustable folding arm
- Combination of MY base and MY arm for more design, flexibility and dynamics at the workplace
- System rail mount for use in various system rails from the office furniture industry
- Mounting standard 75/100 mm
- Mounting of flat screens up to 5 kg
- Range: 415 mm
- Monitor arm infinitely adjustable in height, tilt and rotation
- Height of the column: 350 mm
- Supplied with cable clips
- Combinable with NOVUS MY tab and NOVUS Quick Release

Colours	Art.No.	EAN Code
 	910+2069+000	4009729052082

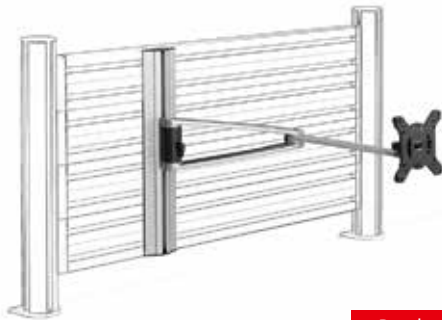

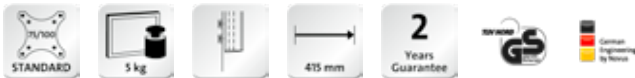

Product expires
on 31.12.2020!



NOVUS MY one plus SW, with organisation wall mount

- Elegant monitor holder with infinitely height adjustable folding arm
- Combination of MY base and MY arm for more design, flexibility and dynamics at the workplace
- Adaption to the organisation wall via slot nuts
- Mounting standard 75/100 mm
- Mounting of flat screens up to 5 kg
- Range: 415 mm
- Monitor arm infinitely adjustable in height, tilt and rotation
- Height of the column: 350 mm
- Supplied with cable clips
- Delivery without SlatWall
- Combinable with NOVUS MY tab and NOVUS Quick Release

Colours	Art.No.	EAN Code
 	910+2079+000	4009729053478

Flat screen holder Novus MY

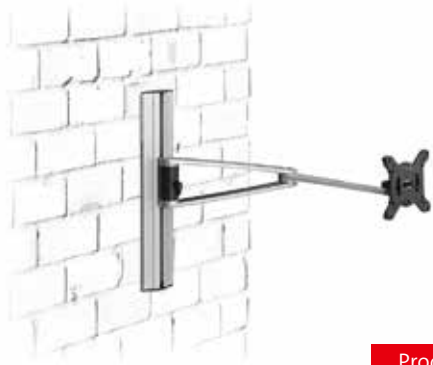



Product expires on 31.12.2020!



NOVUS MY one plus W, with wall mount

- Elegant monitor holder with infinitely height adjustable folding arm
- Combination of MY base and MY arm for more design, flexibility and dynamics at the workplace
- Wall mounting with screws
- Mounting standard 75/100 mm
- Mounting of flat screens up to 5 kg
- Range: 415 mm
- Monitor arm infinitely adjustable in height, tilt and rotation
- Height of the column: 350 mm
- Combinable with NOVUS MY tab and NOVUS Quick Release

Colours	Art.No.	EAN Code
 	910+2089+000	4009729053485





Product expires on 31.12.2020!



NOVUS MY twin fix C, with system clamp

- Elegant monitor holder with two support carriages infinitely adjustable in height
- Combination of MY base and MY fix functional and well designed for the attachment of two opposite monitors
- Table mounting with system clamp 1 for a desktop thickness of 14-40 mm
- Mounting standard 75/100 mm
- Mounting of two flat screens up to 5 kg
- Rotation and tilt is given by the cross joint for more mobility at limited space
- Range: 50 mm
- Height of the column: 350 mm
- Supplied with cable clips
- Combinable with NOVUS MY tab and NOVUS Quick Release

Colours	Art.No.	EAN Code
 	910+1119+000	4009729052174

Enjoy our new NOVUS MY Series
with improved functions from
01/04/2020!





Product expires
on 31.12.2020!



NOVUS MY twin fix D, with drilling screw fitting

- Elegant monitor holder with two support carriages infinitely adjustable in height
- Combination of MY base and MY fix functional and well designed for the attachment of two opposite monitors
- Table mount with drilling screw fitting for a table thickness of 5-70 mm
- Mounting standard 75/100 mm
- Mounting of two flat screens up to 5 kg
- Rotation and tilt is given by the cross joint for more mobility at limited space
- Range: 50 mm
- Height of the column: 350 mm
- Supplied with cable clips
- Combinable with NOVUS MY tab and NOVUS Quick Release

Colours	Art.No.	EAN Code
 	910+1149+000	4009729052181





Product expires
on 31.12.2020!



NOVUS MY twin fix G, with cable port attachment

- Elegant monitor holder with two support carriages infinitely adjustable in height
- Combination of MY base and MY fix functional and well designed for the attachment of two opposite monitors
- Table mount with cable port attachment for a table thickness of 5-70 mm
- Mounting standard 75/100 mm
- Mounting of two flat screens up to 5 kg
- Rotation and tilt is given by the cross joint for more mobility at limited space
- Range: 50 mm
- Height of the column: 350 mm
- Supplied with cable clips
- Combinable with NOVUS MY tab and NOVUS Quick Release

Colours	Art.No.	EAN Code
 	910+1159+000	4009729052198

Flat screen holder Novus MY





Product expires on 31.12.2020!



NOVUS MY twin fix S, with system rail mount

- Elegant monitor holder with two support carriages infinitely adjustable in height
- Combination of MY base and MY fix functional and well designed for the attachment of two opposite monitors
- System rail mount for use in various system rails from the office furniture industry
- Mounting standard 75/100 mm
- Mounting of two flat screens up to 5 kg
- Rotation and tilt is given by the cross joint for more mobility at limited space
- Range: 50 mm
- Height of the column: 350 mm
- Supplied with cable clips
- Combinable with NOVUS MY tab and NOVUS Quick Release

Colours	Art.No.	EAN Code
	 910+1169+000	4009729052204





Product expires on 31.12.2020!



NOVUS MY twin arm C, with system clamp

- Elegant monitor holder with two infinitely height adjustable folding arms
- Combination of MY base and two MY arm attractive appearance with maximum flexibility in the positioning of two monitors
- Table mounting with system clamp 1 for a desktop thickness of 14-40 mm
- Mounting standard 75/100 mm
- Mounting of two flat screens up to 5 kg
- Range: 415 mm
- Monitor arm infinitely adjustable in height, tilt and rotation
- Height of the column: 350 mm
- Supplied with cable clips
- Combinable with NOVUS MY tab and NOVUS Quick Release

Colours	Art.No.	EAN Code
	 910+2219+000	4009729052136

Enjoy our new NOVUS MY Series
with improved functions from
01/04/2020!



Product expires
on 31.12.2020!



NOVUS MY twin arm D, with drilling screw fitting

- Elegant monitor holder with two infinitely height adjustable folding arms
- Combination of MY base and two MY arm attractive appearance with maximum flexibility in the positioning of two monitors
- Table mount with drilling screw fitting for a table thickness of 5-70 mm
- Mounting standard 75/100 mm
- Mounting of two flat screens up to 5 kg
- Range: 415 mm
- Monitor arm infinitely adjustable in height, tilt and rotation
- Height of the column: 350 mm
- Supplied with cable clips
- Combinable with NOVUS MY tab and NOVUS Quick Release

Colours	Art.No.	EAN Code
	910+2249+000	4009729052143



Product expires
on 31.12.2020!



NOVUS MY twin arm G, with cable port attachment

- Elegant monitor holder with two infinitely height adjustable folding arms
- Combination of MY base and two MY arm attractive appearance with maximum flexibility in the positioning of two monitors
- Table mount with cable port attachment for a table thickness of 5-70 mm
- Mounting standard 75/100 mm
- Mounting of two flat screens up to 5 kg
- Range: 415 mm
- Monitor arm infinitely adjustable in height, tilt and rotation
- Height of the column: 350 mm
- Supplied with cable clips
- Combinable with NOVUS MY tab and NOVUS Quick Release

Colours	Art.No.	EAN Code
	910+2259+000	4009729052150

Flat screen holder Novus MY





Product expires on 31.12.2020!



NOVUS MY twin arm S, with system rail mount







- Elegant monitor holder with two infinitely height adjustable folding arms
- Combination of MY base and two MY arm attractive appearance with maximum flexibility in the positioning of two monitors
- System rail mount for use in various system rails of the office furniture industry
- Mounting standard 75/100 mm
- Mounting of two flat screens up to 5 kg
- Range: 415 mm
- Monitor arm infinitely adjustable in height, tilt and rotation
- Height of the column: 350 mm
- Supplied with cable clips
- Combinable with NOVUS MY tab and NOVUS Quick Release

Colours	Art.No.	EAN Code
 	910+2269+000	4009729052167



NOVUS MY base W, with wall rail

- Wall mounting with screws
- Flat distance to the wall of about 20 mm
- Available in lengths: 350 mm, 450 mm and 890 mm
- Covered screw holes
- Customised lengths on request

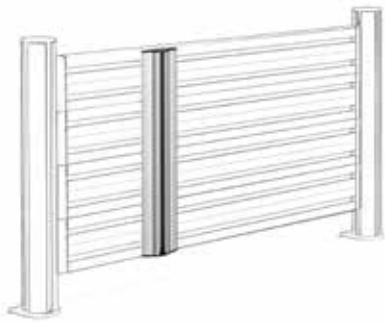

Colours	Art.No.	EAN Code
 	911+0089+000	4009729052952
 	911+0189+000	4009729053355
 	911+0289+000	4009729053362

Enjoy our new NOVUS MY Series
with improved functions from
01/04/2020!



NOVUS MY base SW

- Aluminium profile for mounting on an organisation wall
- Adaption to the organisation wall via slot nuts
- Flat distance to the wall of about 20 mm
- Height of the column: 350 mm
- Covered screw holes
- Fastening material included

Colours	Art.No.	EAN Code
 	911+0079+000	4009729052945



NOVUS MY fix

- Infinitely height adjustable support carriage with VESA standard 75/100
- Mounting of flat screens up to 5 kg
- Rotation and tilt is given by the cross joint for more mobility at limited space
- Range: 50 mm
- Balance mechanism at the front joint for optimum monitor positioning
- MY base as a mandatory extension

Colours	Art.No.	EAN Code
	911+1009+000	4009729052013

Product expires
on 31.12.2020!



Flat screen holder Novus MY



Product expires on 31.12.2020!



NOVUS MY arm

- Infinitely height adjustable 2-part articulated arm with standard VESA 75/100
- Mounting of flat screens up to 5 kg
- Rotatable and swivelling
- Range: 415 mm
- Balance mechanism at the front joint for optimum monitor positioning
- Enables horizontal positioning of the screen
- Includes two cable clips
- MY base as a mandatory extension

Colours	Art.No.	EAN Code
	911+2009+000	4009729052037



Product expires on 31.12.2020!



NOVUS MY notebookarm

- High quality notebook holder with 2-part aluminium arm, infinitely adjustable
- Support platform (404 x 288 mm) for regular and large notebooks
- Carrying capacity 5 kg
- Turn- and tiltable up to 45°
- Grommet in the support plate
- MY base as a mandatory extension

Colours	Art.No.	EAN Code
	911+4009+000	4009729055359

Enjoy our new **NOVUS MY Series**
with improved functions from
01/04/2020!



NOVUS MY arm clip

- Transparent cable clip for optimal cable management at the arm
- Supplied in a set of 2

Colours	Art.No.	EAN Code
	911+0100+000	4009729053492

2
Years
Guarantee



NOVUS MY base clip

- Transparent cable clip for optimal cable management at the column
- Supplied in a set of 2

Colours	Art.No.	EAN Code
	911+0010+000	4009729053508

2
Years
Guarantee

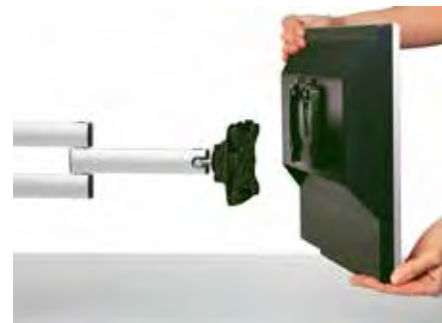

Flat screen holder Novus MY



NOVUS MY tab

- Unique tablet holder that makes it very easy to insert and remove a variety of tablets
- Tablet mount for tablets with a size of 7" to 10" (clamping length 160-300 mm)
- Tablets can be used in portrait or landscape format
- For attachment to NOVUS MY fix, NOVUS MY arm and NOVUS TSS support elements

Colours	Art.No.	EAN Code
	911+3005+000	4009729052525



NOVUS QuickRelease





- Quick release system for NOVUS MY fix and NOVUS MY arm and other NOVUS support elements
- Enables quick and easy monitor change without tools

Colours	Art.No.	EAN Code
	795+9095+000	4009729052860



NOVUS MY toolbar

- SlatWall element with two slots for attaching accessories and monitor arms
- Desktop mount with system clamp 1 (MY Clamp 14-40 mm)
- Available in length: 1200mm, 1600mm

Colours	Art.No.	EAN Code
 	915+1209+000	4009729062234
 	915+1609+000	4009729062241

Novus Tetra Support System: reliable solutions to meet the highest demands

The cutting-edge flat screen monitor holders of the Novus Tetra Support System provide monitors with new-found mobility. Whether in the office or in the control centre, the Tetra Support System has a secure and flexible monitor mount to suit every workstation. With a range of combination options to choose from, flexibility takes on a whole new meaning.

A product range that responds to individual customer requirements.

Sophisticated functionality: Novus TSS monitor support arms

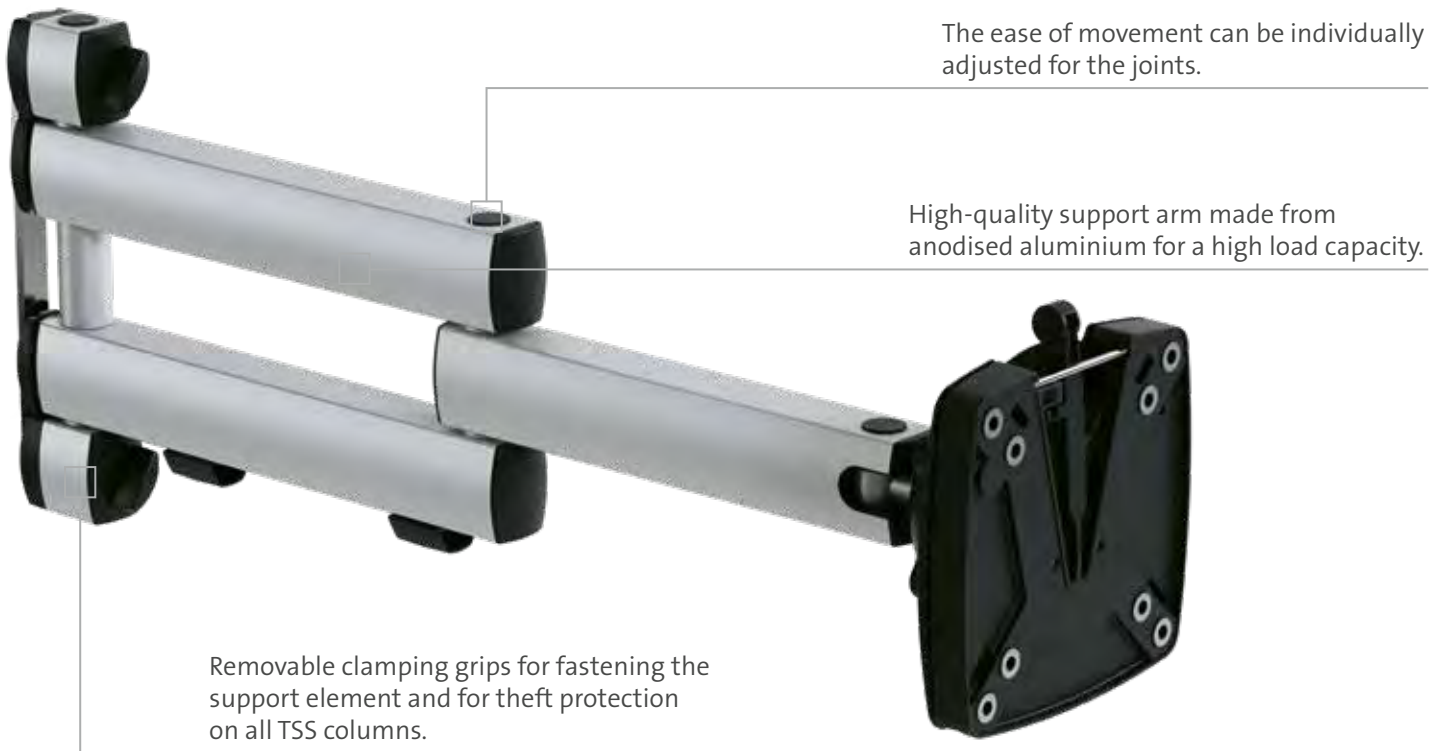

Mounts for every workstation

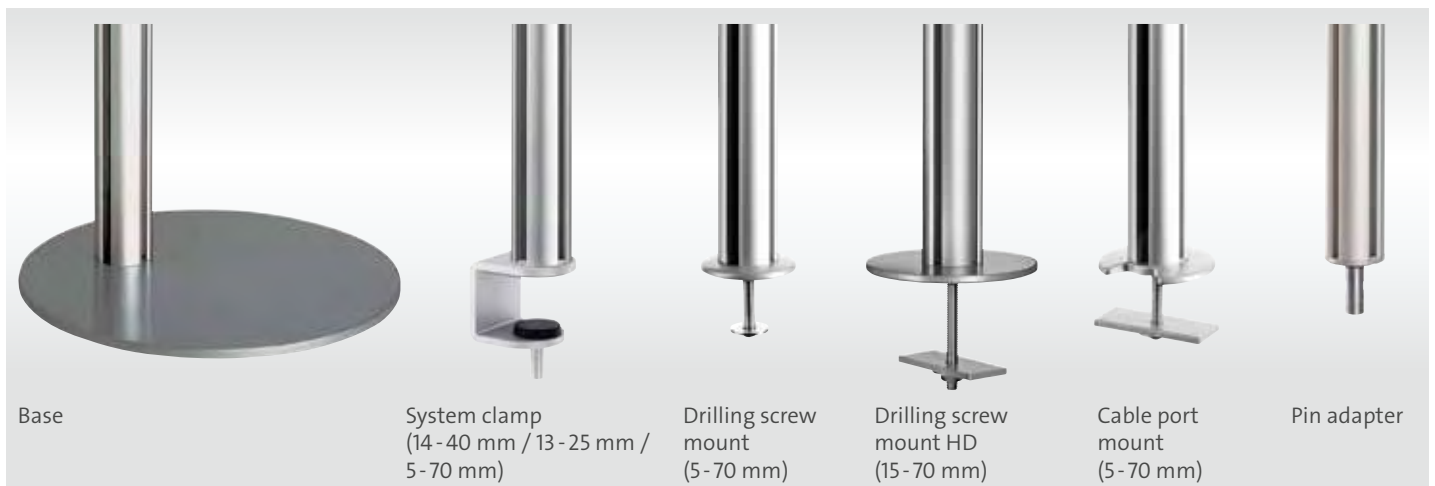

Flat screen supports Novus Tetra-Support-System

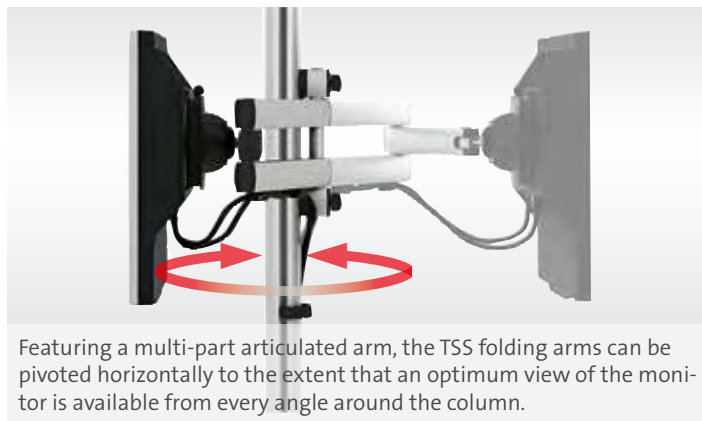
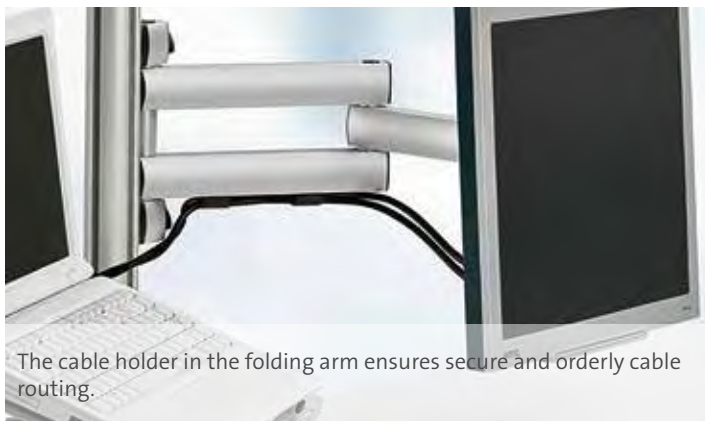
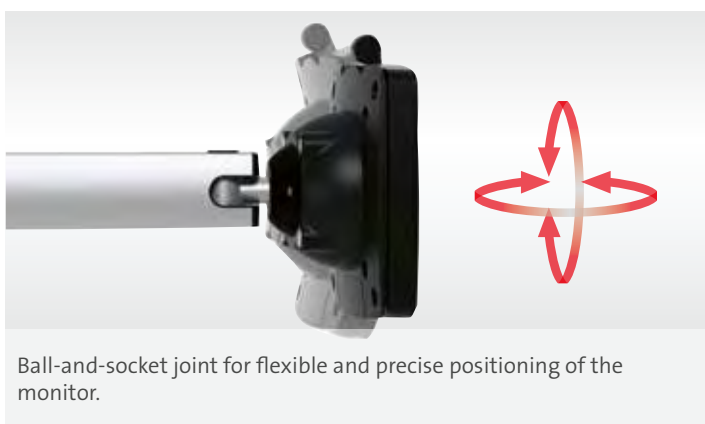
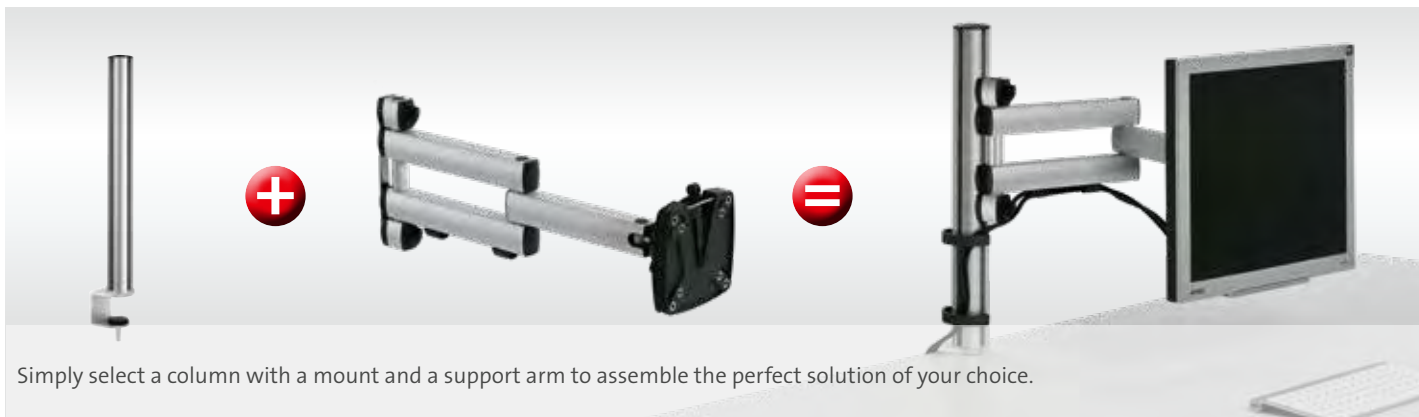

Flexible combination of all components





NOVUS TSS column with support foot





- Aluminium column with four slots and base
- Solid base weighing 4 kg with rubber pads to protect the desk surface and for stability
- Available in length: 445 mm
- Includes two cable clips
- For TSS support carriage

Colours	Art.No.	EAN Code
 	961+0309+000	4009729030585



NOVUS TSS column with system clamp 1 (14-40mm)

- Aluminium column with four slots and system clamp 1
- Table mounting with system clamp 1 for a desktop thickness of 14-40 mm
- Available in length: 445 mm and 545 mm
- Includes two cable clips
- Suitable for all TSS support elements

Colours	Art.No.	EAN Code
 	961+0609+000	4009729033661
 	961+0639+000	4009729042151





Flat screen supports Novus Tetra-Support-System



NOVUS TSS column with system clamp 1 (13-25 mm)





- Aluminium column with four slots and system clamp 1
- Table mounting with system clamp 1 for a desktop thickness of 13-25 mm, ideal for mounting on sliding tabletops
- Available in length: 445 mm
- Includes two cable clips
- Suitable for all TSS support elements

Colours	Art.No.	EAN Code
 	961+2709+000	4009729045015



NOVUS TSS column with system clamp 2 (5-70 mm)

- Aluminium column with four slots and system clamp 2
- Table mounting with system clamp 2 for a desktop thickness of 5-70 mm
- Available in length: 445 mm and 545 mm
- Includes two cable clips
- Suitable for all TSS support elements







Colours	Art.No.	EAN Code
 	961+0209+000	4009729027974
 	961+0239+000	4009729042168





NOVUS TSS column with drilling screw fitting





- Aluminium column with four slots and drilling screw fitting
- Table mount with drilling screw fitting for a table thickness of 5-70 mm
- Available in length: 445 mm, 545 mm and 845 mm
- Includes two cable clips
- Suitable for all TSS support elements

Colours	Art.No.	EAN Code
 	961+0109+000	4009729027950
 	961+0139+000	4009729042182
 	961+0119+000	4009729027967



NOVUS TSS column with drilling screw fitting HD

- Aluminium column with four slots and heavy duty drilling screw mounting
- Drilling screw fitting HD, for desktop thickness 15-70 mm
- Available in length: 445 mm and 845 mm
- Includes two cable clips
- Suitable for all TSS support elements







Colours	Art.No.	EAN Code
 	961+1809+000	4009729050408
 	961+1819+000	4009729050422

Flat screen supports Novus Tetra-Support-System



NOVUS TSS column with cable port fitting



- Aluminium column with four slots and cable port attachment
- Table mount with cable port attachment for a table thickness of 5-70 mm
- Available in length: 445 mm, 545 mm and 845 mm
- Includes two cable clips
- Suitable for all TSS support elements

Colours	Art.No.	EAN Code
 	961+0409+000	4009729033333
 	961+0439+000	4009729042175
 	961+0419+000	4009729033456



NOVUS TSS column with location pin adaption



- Aluminium column with four slots and pin adapter
- Table mount with pin adapter (diameter 16 mm) for use in various table adapters of the office furniture industry
- Height of the column: 445 mm
- Includes two cable clips
- Suitable for all TSS support elements

Colours	Art.No.	EAN Code
 	961+2509+000	4009729045008



NOVUS TSS column with system rail mounting





- Aluminium column with four slots and system rail attachment
- System rail mount for use in various system rails of the office furniture industry
- Available in length: 445 mm
- Includes two slot nuts and two cable clips
- Suitable for all TSS support elements

Colours	Art.No.	EAN Code
 	961+2309+000	4009729044995



NOVUS TSS wall rail

- Aluminium column (depth of 38,5 mm) with three slots for wall
- Wall mounting with screws
- Available in length: 445 mm and 890 mm
- Width of the column: 51 mm
- Includes two cable clips
- Can be combined with SlatWall elements
- Suitable for all TSS support elements

Colours	Art.No.	EAN Code
 	961+0509+000	4009729033463
 	961+0519+000	4009729033470



Flat screen supports Novus Tetra-Support-System



NOVUS TSS column with ceiling mount



- Aluminium column with four slots and ceiling mount
- For mounting at the ceiling, depending on ceiling texture
- Height of the column: 845 mm
- Includes two cable clips
- Suitable for all TSS support elements

Colours	Art.No.	EAN Code
 	961+0819+000	4009729042144



NOVUS TSS column with floor-ceiling mount

- Aluminium column with four slots and ceiling/floor mount
- For mounting between the ceiling and floor, depending on the ceiling and floor texture
- Special dimensions on request
- Including mounts, the column has a length of 2500mm, with length compensation from -15 to +15 mm
- Includes two cable clips
- Suitable for all TSS support elements

Colours	Art.No.	EAN Code
 	961+0949+000	4009729044254





NOVUS TSS support carriage 32

- High quality infinitely height adjustable support carriage
- Suitable for mounting standards: 100x100 and 200x100
- Mounting of flat screens up to 20 kg
- Restrict movement by tightening the joints
- Rotatable for movement on limited space
- Range: 64 mm
- In high-quality aluminium and metal
- Supplied with fixing screws M5 and M6
- Obligatory supplement is a TSS column

Colours	Art.No.	EAN Code
	963+0029+001	4009729044230



NOVUS TSS supporting arm 32

- High quality infinitely height adjustable support arm
- Suitable for mounting standards: 100x100 and 200x100
- Mounting of flat screens up to 20 kg
- Restrict movement by tightening the joints
- Rotatable and swivelling
- Range: 187 mm
- In high-quality aluminium and metal
- Supplied with fixing screws M5 and M6
- Obligatory supplement is a TSS column

Colours	Art.No.	EAN Code
	962+0029+000	4009729044223



Flat screen supports Novus Tetra-Support-System



NOVUS TSS support carriage

- High quality infinitely height adjustable support carriage
- Easy mounting of the monitor by quick release, suitable for mounting standard 75/100
- Mounting of flat screens up to 15 kg
- Restrict movement by tightening the joints
- Swivelling and tiltable
- Range: 105 mm
- In high-quality aluminium and metal
- Removable clamping grips for protection from theft
- Obligatory supplement is a TSS column

Colours	Art.No.	EAN Code
	963+0119+000	4009729047002



NOVUS TSS support arm

- High quality infinitely height adjustable 1-part monitor support arm
- Easy mounting of the monitor by quick release, suitable for mounting standard 75/100
- Mounting of flat screens up to 15 kg
- Restrict movement by tightening the joints
- Easy monitor adjustment by different joints
- Range: 250 mm
- Perfect cable management by cable clips
- In high-quality aluminium and metal
- Removable clamping grips for protection from theft
- Obligatory supplement is a TSS column

Colours	Art.No.	EAN Code
	962+0119+000	4009729046999



NOVUS TSS support arm XL 325

- High quality infinitely height adjustable 1-part monitor support arm
- In a double solution, the extra-long arm can also be used for attaching large monitors side by side
- Easy mounting of the monitor by quick release, suitable for mounting standard 75/100
- Mounting of flat screens up to 15 kg
- Restrict movement by tightening the joints
- Easy monitor adjustment by different joints
- Range: 325 mm
- Perfect cable management by cable clips
- In high-quality aluminium and metal
- Removable clamping grips for protection from theft
- Obligatory supplement is a TSS column



Colours	Art.No.	EAN Code
	962+0119+001	4009729051528



NOVUS TSS folding arm II

- High quality infinitely height adjustable 2-part monitor support arm
- Easy mounting of the monitor by quick release, suitable for mounting standard 75/100
- Mounting of flat screens up to 10 kg
- Restrict movement by tightening the joints
- Ergonomic monitor setting by various joints
- Range: 450 mm
- Perfect cable management by cable clips
- In high-quality aluminium and metal
- Removable clamping grips for protection from theft
- Obligatory supplement is a TSS column



Colours	Art.No.	EAN Code
	964+0119+000	4009729046982

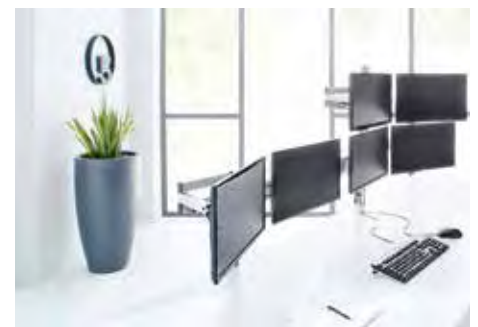

Flat screen supports Novus Tetra-Support-System



NOVUS TSS folding arm III

- High quality 2-part articulated arm, infinitely height adjustable
- Easy mounting of the monitor by quick release, suitable for mounting standard 75/100
- Mounting of flat screens up to 15 kg
- Restrict movement by tightening the joints
- Ergonomic monitor setting by various joints
- Range: 505 mm
- Perfect cable management by cable clips
- Removable clamping grips for protection from theft
- Obligatory supplement is a TSS column



Colours	Art.No.	EAN Code
	965+0119+000	4009729046975



NOVUS TSS folding arm III XL (700)

- High quality 2-part articulated arm, infinitely height adjustable
- Easy mounting of the monitor by quick release, suitable for mounting standard 75/100
- Mounting of flat screens up to 10 kg
- Restrict movement by tightening the joints
- Ergonomic monitor setting by various joints
- Range: 700 mm
- Perfect cable management by cable clips
- Removable clamping grips for protection from theft
- Obligatory supplement is a TSS column



Colours	Art.No.	EAN Code
	965+0119+001	4009729047514



NOVUS TSS folding arm III XL (800)

- High quality 2-part articulated arm, infinitely height adjustable
- Easy mounting of the monitor by quick release, suitable for mounting standard 75/100
- Mounting of flat screens up to 10 kg
- Restrict movement by tightening the joints
- Ergonomic monitor setting by various joints
- Range: 800 mm
- Perfect cable management by cable clips
- Removable clamping grips for protection from theft
- Obligatory supplement is a TSS column

Colours	Art.No.	EAN Code
	965+0119+003	4009729047521



NOVUS TSS folding arm III XL (900)

- High quality 2-part articulated arm, infinitely height adjustable
- Easy mounting of the monitor by quick release, suitable for mounting standard 75/100
- Mounting of flat screens up to 10 kg
- Restrict movement by tightening the joints
- Ergonomic monitor setting by various joints
- Range: 900 mm
- Perfect cable management by cable clips
- Removable clamping grips for protection from theft
- Obligatory supplement is a TSS column

Colours	Art.No.	EAN Code
	965+0119+004	4009729047538

Flat screen supports Novus Tetra-Support-System



NOVUS TSS telescope arm III

- Telescopic monitor arm, infinitely adjustable in height and length
- Classy aluminium finish with anodised surfaces
- Easy mounting of the monitor by quick release, suitable for mounting standard 75/100
- Mounting of flat screens up to 10 kg
- Easy monitor adjustment by different joints and telescopic sliding mechanism
- Range: 314 - 400 mm
- Perfect cable management by cable clips
- Removable clamping grips for protection from theft
- Obligatory supplement is a TSS column

Colours	Art.No.	EAN Code
	968+0119+000	4009729061992



NOVUS telescope arm III XL 700

- Telescopic monitor arm, infinitely adjustable in height and length
- Classy aluminium finish with anodised surfaces
- Easy mounting of the monitor by quick release, suitable for mounting standard 75/100
- Mounting of flat screens up to 8 kg
- Easy monitor adjustment by different joints and telescopic sliding mechanism
- Range: 476-724 mm
- Perfect cable management by cable clips
- Removable clamping grips for protection from theft
- Obligatory supplement is a TSS column

Colours	Art.No.	EAN Code
	968+0119+001	4009729063866

NOVUS TSS notebook holder

- High quality notebook holder with 2-part aluminium arm, infinitely adjustable
- Support platform (404 x 288 mm) for regular and large notebooks
- Carrying capacity up to 10 kg
- Turn- and tiltable up to 25°
- Range: 589 mm
- Grommet in the support plate
- Removable clamping grips for protection from theft and cable holder
- Obligatory supplement is a TSS column



Colours	Art.No.	EAN Code
	966+0119+000	4009729047156

NOVUS TSS keyboard holder

- High quality keyboard holder with 2-part aluminium arm, infinitely adjustable
- Support platform for computer keyboard and mouse (640 x 172 mm)
- Restrict movement by tightening the joints
- Turn- and tiltable up to 25°
- Range: 528 mm
- Removable clamping grips for protection from theft and cable holder
- Obligatory supplement is a TSS column



Colours	Art.No.	EAN Code
	967+0119+000	4009729047163

Flat screen supports Novus Tetra-Support-System



NOVUS TSS-keyboard arm XL 700

- High-quality, infinitely adjustable keyboard holder with extra-long, two-piece articulated arm
- Support platform for computer keyboard and mouse (640 x 172 mm)
- Restrict movement by tightening the joints
- Turn- and tiltable up to 25°
- Range: 728 mm
- Removable clamping grips for protection from theft and cable holder
- Obligatory supplement is a TSS column

Colours	Art.No.	EAN Code
	967+0119+001	4009729051757

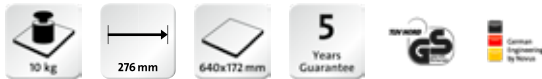

NOVUS TSS keyboard adapter

- Practical keyboard adapter for mounting between support element and monitor
- Support platform for computer keyboard and mouse (640 x 172 mm)
- range: 276 mm
- Practical cable clips route the cables for keyboard and mouse along the centre
- incl. two cable clips for an optimal cable management
- Obligatory supplement is a NOVUS support arm for monitors

Colours	Art.No.	EAN Code
	795+9159+000	4009729054345



NOVUS Thin Client holder

- Holder for Thin Clients of 35 to 53 mm in width
- The holder can be infinitely adjusted to the width of the Thin Client
- Suitable for attachment to a column, to an organisation wall or directly between a support element and a monitor
- Mounting standard 100x100
- Carrying capacity: Thin Client weight 7,5 kg

Colours	Art.No.	EAN Code
	795+9085+000	4009729058381

5
Years
Guarantee



NOVUS drop guard

- Prevents monitor arms from slipping off
- Can also be used as anti-theft device

Colours	Art.No.	EAN Code
	795+9100+000	4009729033012



Flat screen supports Novus Tetra-Support-System



NOVUS TSS cable clips (set of 2)

- Cable support for optimal cable routing directly to the TSS monitor supports
- Available as pack of two

Colours	Art.No.	EAN Code
	961+0105+000	4009729047286

2
Years
Guarantee



NOVUS TSS cable clip set

- Clips for cable management directly at the column
- Available as pack of two

Colours	Art.No.	EAN Code
	961+0005+000	4009729031391







2
Years
Guarantee





NOVUS SlatWall









- Organisation wall for a perfectly organised workspace
- Consisting of: four SlatWall elements, two TSS-445 columns with system clamp 1
- The individual elements can be mounted in various numbers and positions
- Available in the lengths: 800 mm, 1000 mm and 1200 mm (measurement includes NOVUS TSS columns)
- Can be combined with monitor support elements, SlatWall boards and storage accessories

Colours	Art.No.	EAN Code
 	974+0805+000	4009729035795
 	974+1005+000	4009729035504
 	974+1205+000	4009729035771

NOVUS SlatWall element

- Element can be combined with an TSS column for a perfectly organized workspace
- Available in the lengths: 800 mm, 1000 mm, 1200 mm and 1600 mm (measurement includes NOVUS TSS column)
- Can be combined with monitor support elements, SlatWall boards and storage accessories









Colours	Art.No.	EAN Code
 	973+0805+000	4009729034941
 	973+1005+000	4009729034958
 	973+1205+000	4009729035764
 	973+1605+000	4009729052518

NOVUS TSS Toolbar

- SlatWall element with two slots for attaching accessories and monitor arms
- Table mounting with system clamp 1
- Available in length: 1200mm, 1400mm & 1600mm



Colours	Art.No.	EAN Code
 	975+1209+000	4009729052877
 	975+1409+000	4009729052884
 	975+1609+000	4009729052891

Flat screen supports Novus Tetra-Support-System

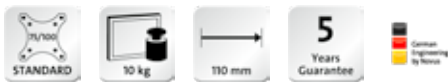

NOVUS SlatWall-support carriage

- High-quality monitor support carriage for mounting a monitor directly to an organisational wall
- For mounting in a single slot
- Easy mounting of the monitor by quick release, suitable for mounting standard 75/100
- Mounting of flat screens up to 10 kg
- High mobility in confined space by ball joint
- Range: 110 mm
- 60° swivelling range for any chosen viewing angle
- Obligatory supplement is a SlatWall element

Colours	Art.No.	EAN Code
	963+0119+013	4009729068137

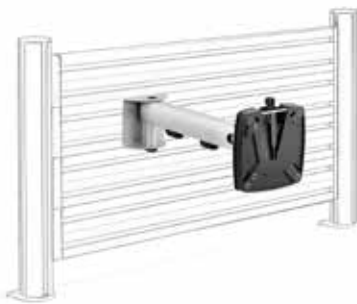

NEW

NOVUS SlatWall support arm

- High-quality monitor support arm for mounting on an organisation wall
- For mounting in a single slot
- Classy aluminium finish with anodised surfaces
- Easy mounting of the monitor by quick release, suitable for mounting standard 75/100
- Mounting of flat screens up to 10 kg
- High mobility in confined space by ball joint
- Range: 300 mm
- Perfect cable management by cable clips
- Obligatory supplement is a SlatWall element

Colours	Art.No.	EAN Code
	962+0119+004	4009729070062

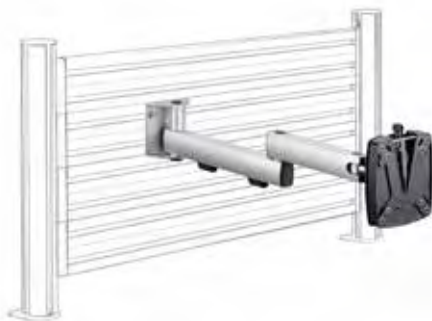

NOVUS SlatWall-folding arm II

- High-quality 2-part monitor arm for mounting a monitor directly to an organisational wall
- For mounting in a single slot
- Classy aluminium finish with anodised surfaces
- Easy mounting of the monitor by quick release, suitable for mounting standard 75/100
- Mounting of flat screens up to 10 kg
- Restrict movement by tightening the joints
- Range: 445 mm
- Perfect cable management by cable clips
- Obligatory supplement is a SlatWall element

Colours	Art.No.	EAN Code
	964+0119+014	4009729068144



Novus SlatWall accessoires



NOVUS SlatWall Cable clip

- Cable clip for optimal cable management at SlatWall
- Available as pack of three



Colours	Art.No.	EAN Code
	796+0005+000	4009729041543

2
Years
Guarantee



NOVUS Penda tray B4 portrait format

- High-quality tray for documents in formats up to DIN B4 portrait
- Dimensions: W 248 mm, H 35 mm, D 297 mm
- In high-quality metal with powder-coated finish
- Obligatory supplement is a SlatWall element

Colours	Art.No.	EAN Code
 	725+0019+000	4009729069219



2 kg

5
Years
Guarantee



NOVUS Penda tray B4 landscape format

- High-quality tray for documents in formats up to DIN B4 landscape
- dimensions: W 327 mm, H 35 mm, D 210 mm
- In high-quality metal with powder-coated finish
- Obligatory supplement is a SlatWall element

Colours	Art.No.	EAN Code
 	725+0029+000	4009729069226

2 kg



5
Years
Guarantee





NOVUS Penda headset holder



- High-quality headset holder
- Dimensions: W 112 mm, H 43 mm, D 48 mm
- Made of high-quality metal with resilient powder coating and foam rubber anti-slip finish
- Obligatory supplement is a SlatWall element

Colours	Art.No.	EAN Code
 	725+0119+000	4009729069318



NOVUS Penda magnetic strip

- High-quality magnetic strip for fastening to an organisation wall
- dimensions: W 300 mm, H 62 mm, D 4 mm
- In high-quality metal with powder-coated finish
- 4 black Dahle magnets Ø 32mm included
- Obligatory supplement is a SlatWall element

Colours	Art.No.	EAN Code
 	725+0109+000	4009729069301





Flat screen supports Novus Tetra-Support-System



NOVUS Penda multi-storage board



- Practical multi-storage board with tube vase and pencil cup
- Dimensions: W 330 mm, H 149 mm, D 160 mm
- In high-quality metal with powder-coated finish
- Obligatory supplement is a SlatWall element

Colours	Art.No.	EAN Code
 	725+0099+000	4009729069295



NOVUS Penda phone holder

- High-quality holder for mobile phones
- dimensions: W 80 mm, H 100 mm, D 62 mm
- Made of high-quality metal with resilient powder coating and foam rubber anti-slip finish
- Obligatory supplement is a SlatWall element



Colours	Art.No.	EAN Code
 	725+0079+000	4009729069271





NOVUS Penda file holder



- File holder
- Dimensions: W 93 mm, H 250 mm, D 180 mm
- In high-quality metal with powder-coated finish
- Obligatory supplement is a SlatWall element

Colours	Art.No.	EAN Code
 	725+0129+000	4009729069325



NOVUS Penda pencil cup

- Taking up very little space on the SlatWall, the pencil cup keeps everything neat and tidy
- Dimensions: W 102 mm, H 93 mm, D 110 mm
- Made of high-quality metal with powder coating pencil cup in plastic
- Obligatory supplement is a SlatWall element

Colours	Art.No.	EAN Code
 	725+0069+000	4009729069264





Flat screen supports Novus Tetra-Support-System



NOVUS Penda tablet holder



- High-quality holder for tablets
- dimensions: W160 mm, H 94,3 mm, D 62 mm
- Made of high-quality metal with resilient powder coating and foam rubber anti-slip finish
- Obligatory supplement is a SlatWall element

Colours	Art.No.	EAN Code
 	725+0089+000	4009729069288



NOVUS Penda large multi-purpose box

- Large, high-quality multi-purpose box for attachment to office-organisation walls
- Dimensions: W 327 mm, H 22 mm, D 120 mm
- In high-quality metal with powder-coated finish
- Obligatory supplement is a SlatWall element



Colours	Art.No.	EAN Code
 	725+0059+000	4009729069257





NOVUS Penda small multi-purpose box

- Small, high-quality multi-purpose box for attachment to office-organisation walls
- dimensions: W163 mm, H 22 mm, D 120 mm
- In high-quality metal with powder-coated finish
- Obligatory supplement is a SlatWall element

Colours	Art.No.	EAN Code
 	725+0049+000	4009729069240



NOVUS Penda memo box

- High-quality memo box for handy notes at eye level
- Dimensions: W 100 mm, H 73 mm, D 100 mm
- In high-quality metal with powder-coated finish
- Obligatory supplement is a SlatWall element

Colours	Art.No.	EAN Code
 	725+0039+000	4009729069233



Flat screen supports Novus Tetra-Support-System









5
Years
Guarantee



NOVUS SlatWall-board

- Elegant filing board for files, books and other office utensils with a large surface thanks depth of 302 mm
- Practical, infinitely adjustable side supports
- Available in length: 600 mm, 800 mm and 1000 mm
- Obligatory supplement is a SlatWall element

Colours	Art.No.	EAN Code
 	760+0605+000	4009729040300
 	760+0805+000	4009729029466
 	760+1005+000	4009729029473



2
Years
Guarantee



NOVUS FileMaster 34

- Shelf for mounting on top of extensible more space system products
- High quality, ribbed aluminium surface with back edge
- Ideal for opposite arranged working surfaces
- Rotating around 360°
- Shelf depth: 304 mm
- Width: 340 mm
- Can also be hooked into SlatWall elements

Colours	Art.No.	EAN Code
	762+0345+000	4009729029442

Novus Clu – perfect for you!

The Novus Clu series of monitor arms gives monitors almost unlimited freedom of movement. The monitor can be turned from landscape to portrait format and moved in any direction, even completely flat up against an organisation wall or acoustic panel. The powerful, adjustable gas spring technology balances the monitor's weight up to a maximum of 7 kg and therefore ensures extremely easy handling at any time.

Elegant 2-part monitor arm with gas spring technology for comfortable, ergonomic monitor adjustment

Particularly suitable for varifocal wearers and touch displays, as the horizontal arm element allows the monitor to be positioned at a particularly low height

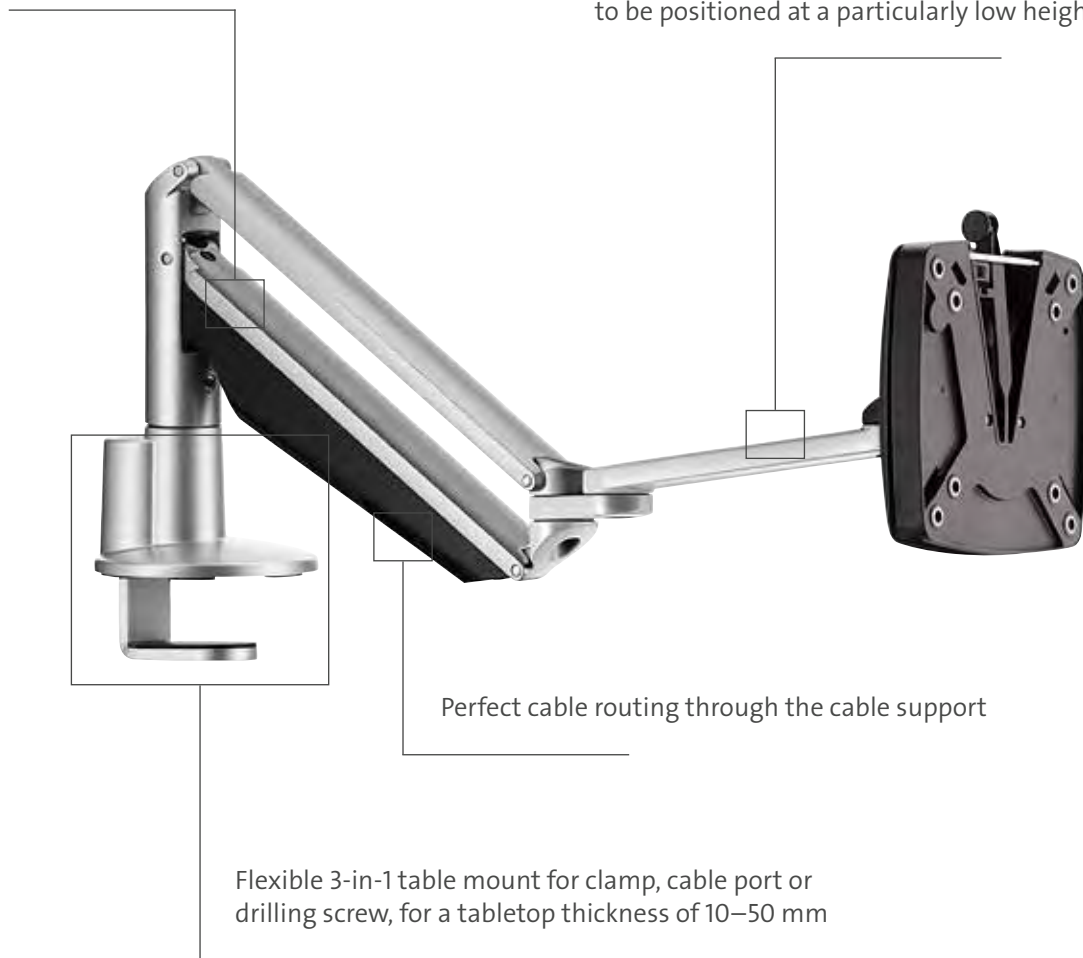



QuickRelease

Monitors can be attached and adjusted **easily by hand** by a single person without any tools. The holder fits all conventional monitors with the mounting standard 75 x 75 and 100 x 100.



Stable joints

The high-quality pivot joint is significantly flatter than a conventional ball-and-socket joint and therefore offers practically unlimited freedom of movement **in every turning and tilting direction**. Even large monitors are easy to handle and will stay securely in the required position.



Clever cable routing

All connection cables are organised and protected under the discreet cover. This also contains the powerful **gas spring** for first-class ease of use.



NOVUS SlatWall

The Clu I SW is ideal for attachment to **organisation walls** and **acoustic panels**, such as the Novus MY toolbar or the Novus SlatWall.



Special project solutions

Various mounting solutions are available to allow you to benefit from the full performance of the new monitor arms even when used in **combination with rail systems**. As well as these, we also develop special solutions for system rails, office partition walls, desks with free-form panels and clamps with different clamping heights and depths on request.



3-in-1 table mount

The standard mount component can easily be attached from above and covers three types of mounts in one: **clamp, cable port or drilling screw**. It is suitable for desktop thicknesses of 10–50 mm and offers optimum flexibility should a different mount from the standard one be required.

3-in-1: in just a few simple steps, the clamp can be turned into a drilling-screw or cable port mount.



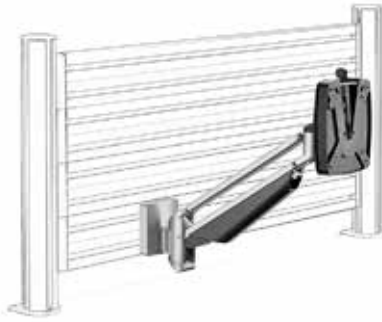



NOVUS Clu I SW, with organisation wall mount

- Elegant 1-part monitor support arm with gas spring technology for a comfortable, ergonomic adjustment of the monitor
- Integrated SlatWall universal adapter for easy mounting with a central screw fitting for mounting in a single or double slot
- Easy mounting of the monitor by quick release, suitable for mounting standard 75/100
- Carrying capacity: Monitor weight 2-7 kg
- Range: 314 mm
- Enables horizontal positioning of the screen
- Perfect cable management
- Obligatory supplement is a SlatWall element



Colours	Art.No.	EAN Code
	990+1071+000	4009729067949
	990+1079+000	4009729066126





NOVUS Clu I c, with table mount

- Elegant 1-part monitor support arm with gas spring technology for a comfortable, ergonomic adjustment of the monitor
- Flexible 3-in-1 table mount for clamp, cable port or drilling screw, for a tabletop thickness of 10-50 mm
- Easy mounting of the monitor by quick release, suitable for mounting standard 75/100
- Carrying capacity: Monitor weight 2-7 kg
- Adjustable inhibition
- 360° rotatable with adjustable stop to 180°
- Range: 283 mm
- Enables horizontal positioning of the screen
- Perfect cable management by cable clips
- Quick and easy mounting

NEW



Colours	Art.No.	EAN Code
	990+1011+000	4009729068281
	990+1018+000	4009729070796
	990+1019+000	4009729068304



Flat screen holder Novus Clu





NOVUS Clu II c, with table mount

- Elegant 2-part monitor supporting arm with gas spring technology for comfortable, ergonomic monitor adjustment
- Flexible 3-in-1 table mount for clamp, cable port or drilling screw, for a tabletop thickness of 10-50 mm
- Easy mounting of the monitor by quick release, suitable for mounting standard 75/100
- Carrying capacity: Monitor weight 2-7 kg
- Adjustable inhibition
- 360° rotatable with adjustable stop to 180°
- Range: 433 mm
- Enables horizontal positioning of the screen
- Perfect cable management by cable clips
- Quick and easy mounting

NEW



Colours	Art.No.	EAN Code
	990+2011+000	4009729068366
	990+2018+000	4009729070833
	990+2019+000	4009729068380







NOVUS Clu III C, with table mount

- Elegant 2-part monitor supporting arm with gas spring technology for comfortable, ergonomic monitor adjustment
- Particularly suitable for varifocal wearers and touch displays, as the horizontal arm element allows the monitor to be positioned at a particularly low height
- Flexible 3-in-1 table mount for clamp, cable port or drilling screw, for a tabletop thickness of 10-50 mm
- Easy mounting of the monitor by quick release, suitable for mounting standard 75/100
- Carrying capacity: Monitor weight 2-7 kg
- Adjustable inhibition
- 360° rotatable with adjustable stop to 180°
- Range: 457 mm
- Perfect cable management by cable clips
- Quick and easy mounting

NEW



Colours	Art.No.	EAN Code
	990+3011+000	4009729068441
	990+3018+000	4009729070871
	990+3019+000	4009729068465



Flat screen holder Novus Clu





NEW



NOVUS Clu Duo C, with table mount

- The dual-monitor solution with gas spring for easy, ergonomic monitor adjustment
- For monitors up to approx. 27 inch
- Flexible 3-in-1 table mount for clamp, cable port or drilling screw, for a tabletop thickness of 10-50 mm
- Easy mounting of the monitor by quick release, suitable for mounting standard 75/100
- For mounting two flat screens of 2 kg to 7 kg each and a max. monitor width of 656 mm
- Adjustable inhibition
- 360° rotatable with adjustable stop to 180°
- Range: 333 mm
- Enables horizontal positioning of the screen
- Perfect cable management by cable clips
- Quick and easy mounting

Colours	Art.No.	EAN Code
	990+4011+000	4009729068489
	990+4018+000	4009729070895
	990+4019+000	4009729068502





NOVUS Clu I, without mount

- Elegant 1-part monitor support arm with gas spring technology for a comfortable, ergonomic adjustment of the monitor
- Easy mounting of the monitor by quick release, suitable for mounting standard 75/100
- Carrying capacity: Monitor weight 2-7 kg
- Adjustable inhibition
- 360° rotatable with adjustable stop to 180°
- Range: 283 mm
- Enables horizontal positioning of the screen
- Perfect cable management
- Obligatory supplement is a Clu mounting
- Quick and easy mounting

NEW



Colours	Art.No.	EAN Code
	990+1001+000	4009729068243
	990+1008+000	4009729070772
	990+1009+000	4009729068267



NOVUS Clu II, without mount

- 2-part monitor supporting arm with gas spring technology for comfortable, ergonomic adjustment
- Easy mounting of the monitor by quick release, suitable for mounting standard 75/100
- Carrying capacity: Monitor weight 2-7 kg
- Adjustable inhibition
- 360° rotatable with adjustable stop to 180°
- Range: 433 mm
- Enables horizontal positioning of the screen
- Perfect cable management by cable clips
- Obligatory supplement is a Clu mounting
- Quick and easy mounting

NEW



Colours	Art.No.	EAN Code
	990+2001+000	4009729068328
	990+2008+000	4009729070819
	990+2009+000	4009729068342

Flat screen holder Novus Clu



NOVUS Clu III, without mount

- 2-part monitor supporting arm with gas spring technology for comfortable, ergonomic adjustment
- Particularly suitable for varifocal wearers and touch displays, as the horizontal arm element allows the monitor to be positioned at a particularly low height
- Easy mounting of the monitor by quick release, suitable for mounting standard 75/100
- Carrying capacity: Monitor weight 2-7 kg
- Adjustable inhibition of the joints
- 360° rotatable with adjustable stop to 180°
- Range: 457 mm
- Perfect cable management by cable clips
- Obligatory supplement is a Clu mounting
- Quick and easy mounting

NEW



Colours	Art.No.	EAN Code
	990+3001+000	4009729068403
	990+3008+000	4009729070857
	990+3009+000	4009729068427

NOVUS Clu column adapter

- Adapter for MY, TSS and Retail columns
- In high-quality aluminium
- Quick and easy mounting



NEW





Colours	Art.No.	EAN Code
	898+0091+000	4009729068601
	898+0098+000	4009729070956
	898+0099+000	4009729068625



Novus Clu clamp (25 mm)

- Clamp for mounting on desktops
- Clamping length: 13-25 mm
- Clamping depth: 25 mm
- Cable clip included for optimum cable routing
- Steel clamp with aluminium casing





Colours	Art.No.	EAN Code
	898+0021+001	4009729071977
	898+0028+001	4009729071984
	898+0029+001	4009729071991



Novus Clu clamp (65 mm)

- Clamp for mounting on desktops
- Clamping length: 13-25 mm
- Clamping depth: 65 mm
- Cable clip included for optimum cable routing
- Steel clamp with aluminium casing





Colours	Art.No.	EAN Code
	898+0021+002	4009729072004
	898+0028+002	4009729072011
	898+0029+002	4009729072028

Flat screen holder Novus Clu



Novus Clu system rail mount

- System rail mount for use in various system rails from the office furniture industry
- Cable clip included for optimum cable routing
- Steel plate with aluminium casing

Colours	Art.No.	EAN Code
	898+0061+000	4009729071953
	898+0068+000	4009729071946
	898+0069+000	4009729071960



2
Years
Guarantee



Novus LiftTEC®: everything perfectly in control

The NOVUS LiftTEC® series enables monitors weighing 3-15 kg to be conveniently and safely secured. Height adjustments are child's play. The gas pressure technology and the ball-and-socket joint make it particularly easy to position the monitor in an ergonomic way. The monitor can therefore be moved quickly to various individual positions.

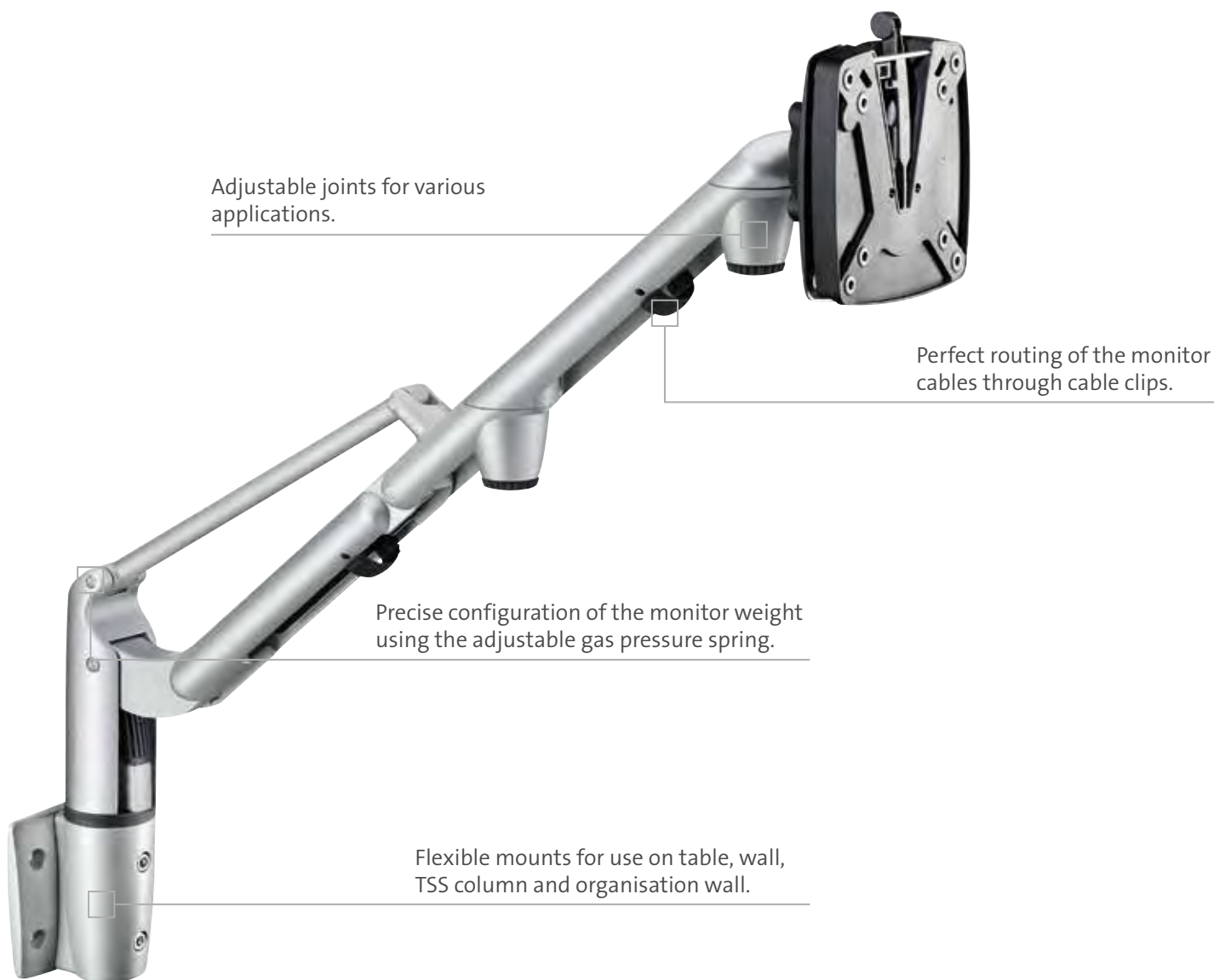

Mounts for every workstation

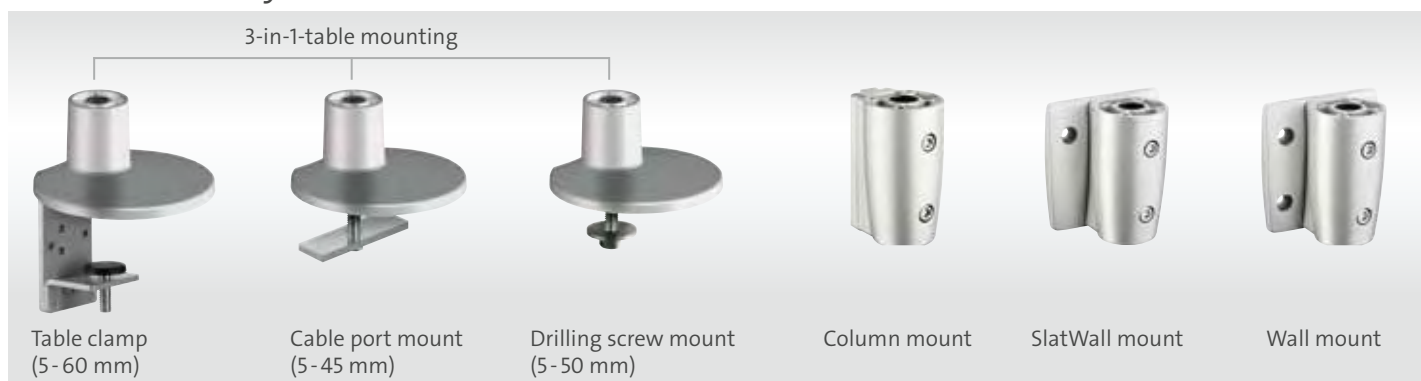

Flat screen holder Novus LiftTEC®

Sophisticated functions for an ergonomic workstation



Easy monitor attachment thanks to QuickRelease. Ball-and-socket joint for setting the optimum viewing angle and for using the pivot function of the monitors to full capacity.



The simple QuickRelease enables the monitor to be effortlessly secured and released via a single-lever operation.



Precise configuration of the LiftTEC® arm in line with the monitor weight using the adjustable gas pressure spring.



The ease of movement can be individually adjusted for the rotating joints.



Perfect cable routing on and in the support arm via the cable clips.







Corresponding to the application: mounting options on table, wall, TSS column or SlatWall.



NOVUS LiftTEC-Arm I, with table mount

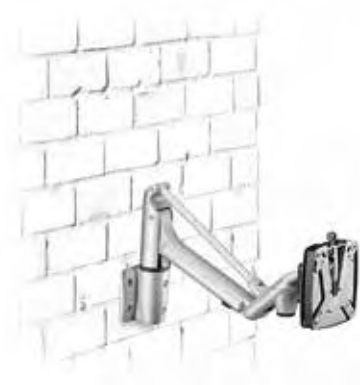

- 1-part monitor supporting arm with gas spring technology for comfortable, ergonomic adjustment
- Flexible 3-in-1 table mount for clamp, cable port or drilling screw
- Easy mounting of the monitor by quick release, suitable for mounting standard 75/100
- Mounting of flat screens of 3-8 kg or 7-15 kg
- Range: 365 mm
- Perfect cable management by cable clips

Colours	Art.No.	EAN Code
 	930+1089+000	4009729044551
 	930+1159+000	4009729044568



NOVUS LiftTEC Arm I, with wall mount

- 1-part monitor supporting arm with gas spring technology for comfortable, ergonomic adjustment of the monitor for mounting directly on the wall
- With wall bracket
- Easy mounting of the monitor by quick release, suitable for mounting standard 75/100
- Mounting of flat screens of 3-8 kg depending on wall texture
- Range: 400 mm
- Perfect cable management by cable clips

Colours	Art.No.	EAN Code
 	931+1089+000	4009729044599

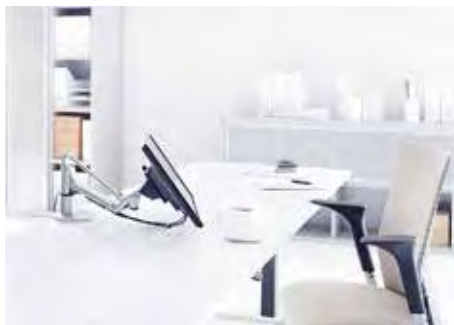



Flat screen holder Novus LiftTEC®

NOVUS LiftTEC-Arm I Dual, with table mount

- Double monitor arm with gas spring for easy, ergonomic monitor adjustment to suit individual requirements
- Flexible 3-in-1 table mount for clamp, cable port or drilling screw
- Easy mounting of the monitor by quick release, suitable for mounting standard 75/100
- For mounting two flat screens of up to 7 kg each, arranged either horizontally or vertically, and a max. monitor width of 656 mm
- Range: 415 mm
- Perfect cable management by cable clips





Colours	Art.No.	EAN Code
  2x7 kg	930+1279+000	4009729046456

NOVUS SlatWall LiftTEC Arm I, with organisation wall mount

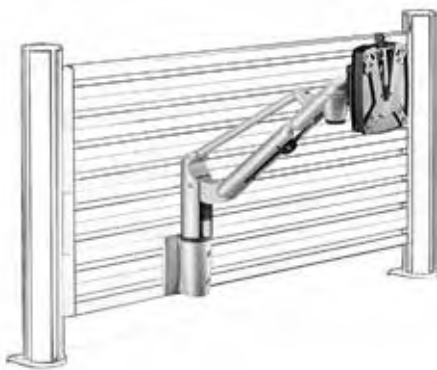
- 1-part monitor supporting arm with gas spring technology for comfortable, ergonomic adjustment
- With SlatWall adapter
- Easy mounting of the monitor by quick release, suitable for mounting standard 75/100
- Mounting of flat screens of 3-8 kg
- Range: 400 mm
- Perfect cable management by cable clips
- Obligatory supplement is a SlatWall element







Colours	Art.No.	EAN Code
  3-8 kg	981+1089+000	4009729044643





NOVUS TSS-LiftTEC-Arm I, with column mount



- 1-part monitor supporting arm with gas spring technology for comfortable, ergonomic adjustment
- With TSS column adapter
- Easy mounting of the monitor by quick release, suitable for mounting standard 75/100
- Mounting of flat screens of 3-8 kg or 7-15 kg
- Range: 397 mm
- Perfect cable management by cable clips
- Obligatory supplement is a TSS column

Colours	Art.No.	EAN Code
 	980+1089+000	4009729044612
 	980+1159+000	4009729044629



NOVUS TSS-LiftTEC-Arm I Dual, with column mount

- Double monitor arm with gas spring for easy, ergonomic monitor adjustment to suit individual requirements
- Easy mounting of the monitor by quick release, suitable for mounting standard 75/100
- Mounting of two flat screens up to 7 kg alongside or above one another
- For mounting flat screens up to maximum monitor width of 27" (656 mm)
- Range: 447 mm
- Perfect cable management by cable clips
- Obligatory supplement is a TSS column

Colours	Art.No.	EAN Code
 	980+1279+000	4009729046463







Flat screen holder Novus LiftTEC®



NOVUS LiftTEC-Arm II, with table mount

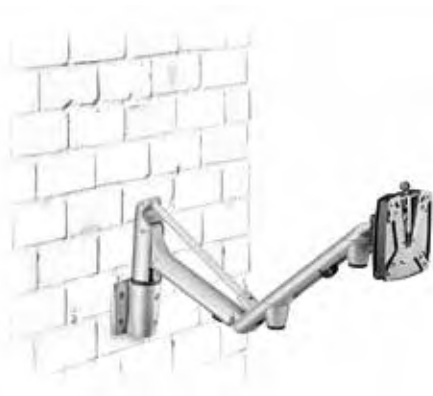

- 2-part monitor supporting arm with gas spring technology for comfortable, ergonomic adjustment
- Flexible 3-in-1 table mount for clamp, cable port or drilling screw
- Easy mounting of the monitor by quick release, suitable for mounting standard 75/100
- Mounting of flat screens of 3-8 kg or 7-15 kg
- Range: 515 mm
- Perfect cable management by cable clips

Colours	Art.No.	EAN Code
 	930+2089+000	4009729043868
 	930+2159+000	4009729043875



NOVUS LiftTEC Arm II, with wall mount





- 2-part monitor supporting arm with gas spring technology for comfortable, ergonomic adjustment of the monitor for mounting directly on the wall
- With wall bracket
- Easy mounting of the monitor by quick release, suitable for mounting standard 75/100
- Mounting of flat screens of 3-8 kg depending on wall texture
- Range: 550 mm
- Perfect cable management by cable clips

Colours	Art.No.	EAN Code
 	931+2089+000	4009729044575



NOVUS TSS-LiftTEC-Arm II, with column mount

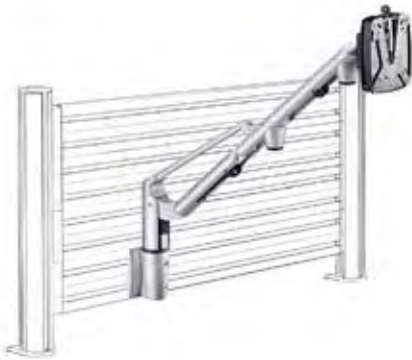

- 2-part monitor supporting arm with gas spring technology for comfortable, ergonomic adjustment
- With TSS column adapter
- Easy mounting of the monitor by quick release, suitable for mounting standard 75/100
- Mounting of flat screens of 3-8 kg or 7-15 kg
- Range: 547 mm
- Perfect cable management by cable clips
- Obligatory supplement is a TSS column

Colours	Art.No.	EAN Code
 	980+2089+000	4009729043882
 	980+2159+000	4009729043899



NOVUS SlatWall LiftTEC Arm II, with organisation wall mount

- 2-part monitor supporting arm with gas spring technology for comfortable, ergonomic adjustment
- With SlatWall adapter
- Easy mounting of the monitor by quick release, suitable for mounting standard 75/100
- Mounting of flat screens of 3-8 kg
- Range: 550 mm
- Perfect cable management by cable clips
- Obligatory supplement is a SlatWall element

Colours	Art.No.	EAN Code
 	981+2089+000	4009729044636







Flat screen holder Novus LiftTEC®



NOVUS LiftTEC-Arm III, with table mount

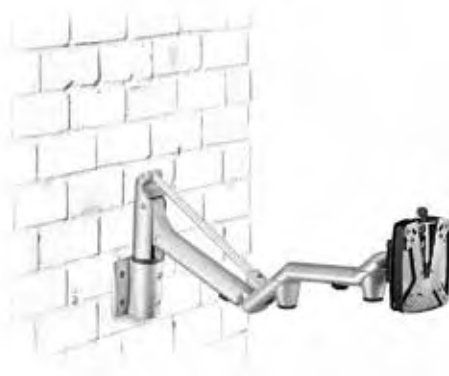

- 2-part monitor supporting arm with gas spring technology for comfortable, ergonomic adjustment
- With straight front arm section for a very low screen positioning
- Flexible 3-in-1 table mount for clamp, cable port or drilling screw
- Easy mounting of the monitor by quick release, suitable for mounting standard 75/100
- Mounting of flat screens of 3-8 kg or 7-15 kg
- Range: 515 mm
- Perfect cable management by cable clips

Colours	Art.No.	EAN Code
 	930+3089+000	4009729045398
 	930+3159+000	4009729045404



NOVUS LiftTEC Arm III, with wall mount

- 2-part monitor supporting arm with gas spring technology for comfortable, ergonomic adjustment of the monitor for mounting directly on the wall
- With straight front arm section for a very low screen positioning
- With wall bracket
- Easy mounting of the monitor by quick release, suitable for mounting standard 75/100
- Mounting of flat screens of 3-8 kg depending on wall texture
- Range: 550 mm
- Perfect cable management by cable clips





Colours	Art.No.	EAN Code
 	931+3089+000	4009729045411





NOVUS TSS-LiftTEC-Arm III, with column mount

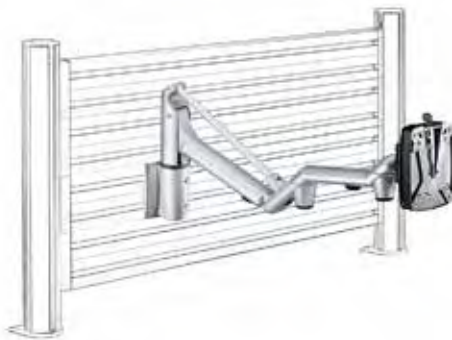

- 2-part monitor supporting arm with gas spring technology for comfortable, ergonomic adjustment
- With straight front arm section for a very low screen positioning
- With TSS column adapter
- Easy mounting of the monitor by quick release, suitable for mounting standard 75/100
- Mounting of flat screens of 3-8 kg or 7-15 kg
- Range: 547 mm
- Perfect cable management by cable clips
- Obligatory supplement is a TSS column

Colours	Art.No.	EAN Code
 	980+3089+000	4009729045435
 	980+3159+000	4009729045442



NOVUS SlatWall LiftTEC Arm III, with organisation wall mount

- 2-part monitor supporting arm with gas spring technology for comfortable, ergonomic adjustment
- With straight front arm section for a very low screen positioning
- With SlatWall adapter
- Easy mounting of the monitor by quick release, suitable for mounting standard 75/100
- Mounting of flat screens up to 10 kg
- Range: 550 mm
- Perfect cable management by cable clips
- delivery without SlatWall
- Obligatory supplement is a SlatWall element

Colours	Art.No.	EAN Code
 	981+3089+000	4009729045459



Flat screen holder Novus LiftTEC®



NOVUS LiftTEC Arm IV with column adapter

- 1-part monitor supporting arm with gas spring technology for comfortable, ergonomic adjustment
- usable for very low position of the screen
- With TSS column adapter
- Flat monitor mounting with cross joint and QuickRelease, suitable for mounting standard 75/100
- Mounting of flat screens of 3-6 kg
- Range: 355 mm
- Perfect cable management by cable clips
- Obligatory supplement is a TSS column

Colours	Art.No.	EAN Code
	980+4069+000	4009729063316

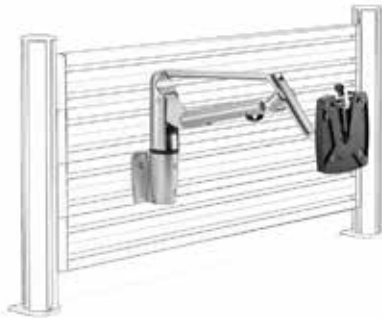

NOVUS SlatWall LiftTEC Arm IV, with organisation wall mount



- 1-part monitor supporting arm with gas spring technology for comfortable, ergonomic adjustment
- usable for very low position of the screen
- With SlatWall adapter
- Flat monitor mounting with cross joint and QuickRelease, suitable for mounting standard 75/100
- Mounting of flat screens of 3-6 kg
- Range: 355 mm
- delivery without SlatWall
- Perfect cable management by cable clips
- Obligatory supplement is a SlatWall element

Colours	Art.No.	EAN Code
	981+4069+000	4009729063323



NOVUS TSS-LM-Arm 0-0-1, with column mount

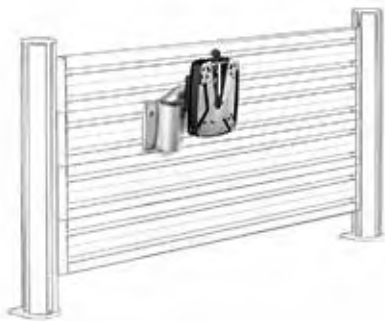

- High quality infinitely height adjustable support carriage
- With TSS column adapter
- Easy mounting of the monitor by quick release, suitable for mounting standard 75/100
- Mounting of flat screens up to 15 kg
- Various joints for high mobility in limited space
- Range: 122 mm
- Obligatory supplement is a TSS column

Colours	Art.No.	EAN Code
 	980+0159+000	4009729045756



NOVUS SlatWall LM-Arm 0-0-1, with SlatWall mount

- High quality support carriage
- With SlatWall adapter
- Easy mounting of the monitor by quick release, suitable for mounting standard 75/100
- Mounting of flat screens up to 8 kg
- High mobility in confined space by ball joint
- Range: 125 mm
- Obligatory supplement is a SlatWall element

Colours	Art.No.	EAN Code
 	981+0089+000	4009729045824





Flat screen holder Novus LiftTEC®



NOVUS LM-Arm 0-0-1, with wall mount



- High quality support carriage for mounting a monitor directly to the wall
- With wall bracket
- Easy mounting of the monitor by quick release, suitable for mounting standard 75/100
- Mounting of flat screens up to 8 kg
- High mobility in confined space by ball joint
- Wall distance: 125 mm

Colours	Art.No.	EAN Code
 	931+0089+000	4009729045688



NOVUS TSS-LM-Arm 0-2-1, with column mount



- High quality infinitely height adjustable 2-part monitor support arm
- With TSS column adapter
- Easy mounting of the monitor by quick release, suitable for mounting standard 75/100
- Mounting of flat screens up to 15 kg
- Ergonomic monitor setting to the personal needs by various joints
- Range: 272 mm
- Perfect cable management by cable clips
- Obligatory supplement is a TSS column

Colours	Art.No.	EAN Code
 	980+4159+000	4009729045763



NOVUS LM-Arm 0-2-1, with wall mount

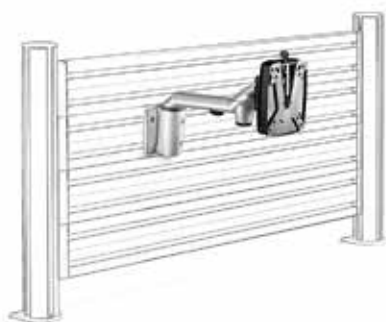

- High quality monitor support for attaching a monitor directly to the wall
- With wall bracket
- Easy mounting of the monitor by quick release, suitable for mounting standard 75/100
- Mounting of flat screens up to 8 kg
- Various joints for high mobility
- Range: 275 mm
- Perfect cable management by cable clips

Colours	Art.No.	EAN Code
 	931+4089+000	4009729045695



NOVUS SlatWall LM-Arm 0-2-1, with organisation wall mount

- High quality monitor support arm
- With straight front arm section for a very low screen positioning
- With SlatWall adapter
- Easy mounting of the monitor by quick release, suitable for mounting standard 75/100
- Mounting of flat screens up to 8 kg
- Various joints for high mobility
- Range: 275 mm
- Perfect cable management by cable clips
- Obligatory supplement is a SlatWall element

Colours	Art.No.	EAN Code
 	981+4089+000	4009729045831



Flat screen holder Novus LiftTEC®



2
Years
Guarantee



NOVUS Balance 30



- Height adjustment to compensate different heights of parallel arranged monitors
- Compensation range: + - 30 mm
- For monitors suitable for mounting standard 75/100
- Necessary when using the SlatWall LM arm 0-0-1 and SlatWall LM arm 0-2-1 in combination next to each other

Colours	Art.No.	EAN Code
	795+9075+000	4009729047170



NOVUS TSS-LM-Arm 0-0-4 Dual, with column mount

- High quality infinitely height adjustable double monitor support arm
- With TSS column adapter
- Easy mounting of the monitor by quick release, suitable for mounting standard 75/100
- Mounting of two flat screens up to 7 kg alongside or above one another
- Range: 172 mm
- Perfect cable management by cable clips
- Obligatory supplement is a TSS column

Colours	Art.No.	EAN Code
 	980+0279+000	4009729046517

Novus Screen Mount: prodigious performance for assured attention



The Novus ScreenMount series is specially designed for mounting heavy (30–100 kg) and particularly large (up to 70 inches) monitors.



Simple, safe and easy to mount on the wall – thanks to an integrated spirit level.

Flat screen holder Novus ScreenMount



NOVUS ScreenMount Fix 400, wall mount

- Sturdy wall mount for mounting large screens particularly close to the wall
- Suitable for mounting standards: 100x100, 200x100, 200x200, 300x300, 400x200, 400x300
- Mounting of flat screens up to 35 kg
- Wall distance: 35 mm
- In high-quality metal with powder-coated finish
- Integrated spirit level for ease of installation

Colours	Art.No.	EAN Code
	940+0405+000	4009729055465



NOVUS ScreenMount Fix 700, wall mount

- Sturdy wall mount for mounting very large flat screens particularly close to the wall
- Suitable for mounting standards: 100x100, 200x100, 200x200, 300x300, 400x200, 400x400, 600x200, 600x400
- Mounting of flat screens up to 45 kg
- Wall distance: 35 mm
- In high-quality metal with powder-coated finish
- Integrated spirit level for ease of installation

Colours	Art.No.	EAN Code
	940+0705+000	4009729055472



NOVUS SKY WallMount

- Wall bracket for attachment to the wall, depending on the wall texture
- Easy mounting of the monitor by quick release, suitable for mounting standard 75/100
- Mounting of flat screens up to 10 kg
- Swivelling and tiltable
- Wall distance: 125 mm

Colours	Art.No.	EAN Code
	950+0019+100	4009729053348



Flat screen holder Novus ScreenMount



NOVUS QuickMount

- For the particularly flat mounting of monitors on the wall
- Easy mounting of the monitor by quick release, suitable for mounting standard 75/100
- For mounting flat screens weighing up to 25 kg
- Wall distance: 20 mm

Colours	Art.No.	EAN Code
	931+0255+000	4009729046043

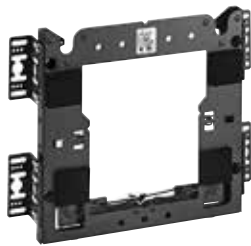

NOVUS ScreenMaster Frame 200x200

- Slim-line wall mount with locking catch for large screens
- Quick fastening system for easy screen attachment
- For mounting screens weighing up to 30 kg
- Distance from wall: from just 30 mm to 50 mm (in 5 stages)
- In high-quality metal with powder-coated finish

Colours	Art.No.	EAN Code
	940+2205+000	4009729058152





NOVUS ScreenMaster Frame 300x300

- Slim-line wall mount with locking catch for large screens
- Quick fastening system for easy screen attachment
- For mounting flat screens weighing up to 30 kg
- Distance from wall: from just 30 mm to 50 mm (in 5 stages)
- In high-quality metal with powder-coated finish

Colours	Art.No.	EAN Code
	940+3305+000	4009729061640



NOVUS ScreenMaster Frame 400x400

- Slim-line wall mount with locking catch for large screens
- Quick fastening system for easy screen attachment
- Mounting of flat screens up to 35 kg
- Distance from wall: from just 30 mm to 50 mm (in 5 stages)
- In high-quality metal with powder-coated finish

Colours	Art.No.	EAN Code
	940+4405+000	4009729058176



Flat screen holder Novus ScreenMount



NOVUS ScreenMaster Frame 600x400

- Slim-line wall mount with locking catch for large screens
- Quick fastening system for easy screen attachment
- Mounting of flat screens up to 35 kg
- Distance from wall: from just 30 mm to 50 mm (in 5 stages)
- In high-quality metal with powder-coated finish

Colours	Art.No.	EAN Code
	940+6405+000	4009729058190



NOVUS ScreenMaster 100

- Very slim wall mount for flat screens
- Quick fastening system for easy screen attachment
- Flat distance to the wall of about 20 mm
- For mounting flat screens weighing up to 25 kg
- In high-quality metal with powder-coated finish

Colours	Art.No.	EAN Code
	940+1009+000	4009729061749





NOVUS standard mounting adapter set

- Adapter plate set for connecting large monitors to attachment standard 200/100 or 200/200
- Suitable for the following mounting standards: 400x400, 300x300

Colours	Art.No.	EAN Code
	795+9105+000	4009729059333



NOVUS spacer set

- Accessories for monitors with deeper standard mount
- Makes easy work of fitting all NOVUS support elements
- Comprising: four spacer rollers and four screws

Colours	Art.No.	EAN Code
	796+0905+000	4009729047606

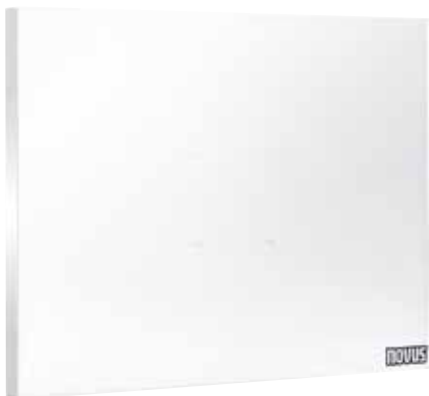

NOVUS dummy monitor

- Dummy monitor for use in showrooms or at trade fairs
- Illustrates how flat screen holders work
- Mounting standard 100x100
- Dimensions: W 430 mm, H 310 mm, D 20 mm
- Transparent acrylic glass with printed NOVUS logo

Colours	Art.No.	EAN Code
	795+9000+000	4009729058787





Flat screen supports Accessories



NOVUS adapter plate 200 x 100

- Adapter plate for connection medium size monitors to the mounting standard 75/100
- Suitable for the following mounting standards: 200x100

Colours	Art.No.	EAN Code
	795+9055+000	4009729044513
	795+9052+000	4009729044506



NOVUS adapter plate 200 x 200

- Adapter plate for connection of large monitors to the mounting standard VESA 75/100
- Suitable for the following mounting standards: 200x100, 200x200



Colours	Art.No.	EAN Code
	795+9065+000	4009729046814





NOVUS TabletCase iPad mini 7,9"



- Premium tablet holder with minimalist design
- Slim tablet frame for iPad Mini 7.9"
- Tablet inserted in seconds
- Camera accessible thanks to aperture for camera hole
- Mounting standard 100x100
- The integrated lock provides secure protection against theft
- Cleverly designed cable routing allows the tablet to be used all the time with the charging cable connected (we recommend using the original cable)
- Classy aluminium finish with anodised surfaces
- High-quality on/off switch with locking function
- Exposed home button for full functionality

Colours	Art.No.	EAN Code
	883+1018+000	4009729067017
	883+1019+000	4009729067024



NOVUS TabletCase iPad 9,7"

- Premium tablet holder with minimalist design
- Slim tablet frame for iPad 9.7"
- Tablet inserted in seconds
- Camera accessible thanks to aperture for camera hole
- Mounting standard 100x100
- The integrated lock provides secure protection against theft
- Cleverly designed cable routing allows the tablet to be used all the time with the charging cable connected (we recommend using the original cable)
- Classy aluminium finish with anodised surfaces
- High-quality on/off switch with locking function
- Exposed home button for full functionality

Colours	Art.No.	EAN Code
	883+1028+000	4009729067031
	883+1029+000	4009729067048





Tablet holder and accessories



NOVUS TabletCase iPad Pro 12,9"



- Premium tablet holder with minimalist design
- Slim tablet frame for iPad Pro 12.9"
- Tablet inserted in seconds
- Camera accessible thanks to aperture for camera hole
- Mounting standard 100x100
- The integrated lock provides secure protection against theft
- Cleverly designed cable routing allows the tablet to be used all the time with the charging cable connected (we recommend using the original cable)
- Classy aluminium finish with anodised surfaces
- High-quality on/off switch with locking function
- Exposed home button for full functionality

Colours	Art.No.	EAN Code
	883+1038+000	4009729067055
	883+1039+000	4009729067062



NOVUS TabletCase Microsoft Surface Pro 4

- Premium tablet holder with minimalist design
- Slim tablet frame for Microsoft Surface Pro 4
- Tablet inserted in seconds
- Camera accessible thanks to aperture for camera hole
- Mounting standard 100x100
- The integrated lock provides secure protection against theft
- Cleverly designed cable routing allows the tablet to be used all the time with the charging cable connected (we recommend using the original cable)
- Classy aluminium finish with anodised surfaces
- High-quality on/off switch with locking function
- Exposed home button for full functionality



Colours	Art.No.	EAN Code
	883+0018+000	4009729066997
	883+0019+000	4009729067000



NOVUS TabletSafe Android

- Mobile tablet holder as the practical and modern basis for presentation and communication
- Universal tablet frame for 10-inch Android tablets
- High-quality metal frame with velour chrome surface and lacquered display bezel
- In the anthracite-coloured version, metal frame and display bezel are finished in matching lacquer
- The integrated lock provides secure protection against theft
- Metal clips in the enclosure permit exact positioning of different tablets in the frame
- Cleverly designed cable routing allows the tablet to be used all the time with the charging cable connected (we recommend using the original cable)
- Dimensions: W 301.5 x H 231.5 x D 20 mm
- Control functions remain accessible by the practical apertures at the backside. They can be closed off with the delivered cover caps.
- Can be combined with TabletSafe stands and wall mounts as well as with all connect columns and connect support arms



Colours	Art.No.	EAN Code
	881+0318+000	4009729057124
	881+0308+000	4009729057131
	881+0301+000	4009729057148





Tablet holder and accessories



NOVUS TabletSafe iPad

- Mobile tablet holder as the practical and modern basis for presentation and communication
- Universal tablet frame for 9-10-inch Apple iPads 9,7 inch (new versions 10,2 & 10,5 inch on request available)
- High-quality metal frame with velour chrome surface and lacquered display bezel
- In the anthracite-coloured version, metal frame and display bezel are finished in matching lacquer
- The integrated lock provides secure protection against theft
- Metal clips in the enclosure permit exact positioning of different tablets in the frame
- Cleverly designed cable routing allows the tablet to be used all the time with the charging cable connected (we recommend using the original cable)
- Dimensions: W 301,5 x H 231,5 x D 20 mm
- Control functions remain accessible by the practical apertures at the backside. They can be closed off with the delivered cover caps.
- Can be combined with TabletSafe stands and wall mounts as well as with all connect columns and connect support arms





Colours	Art.No.	EAN Code
	881+1318+000	4009729057155
	881+1308+000	4009729057162
	881+1301+000	4009729057179





NOVUS DeskStand 200

- Desktop stand for NOVUS TabletSafe
- High-quality, anodised aluminium column with internal cable guide and brushes to allow cables to protrude flexibly at any height
- Stylish metal base provides firm standing
- Ideal for using the TabletSafe on the desk, table or counter
- Moveable connect joint for holding the TabletSafe
- The connect joint provides a swivelling range of 360 degrees - with concealed cable routing, the tablet can be turned through +/- 45 degrees
- Angle of inclination at the connect joint can be adjusted to any position for an optimum viewing angle
- Height of the column: 200mm





Colours	Art.No.	EAN Code
 	882+0205+000	4009729061053
 	882+0209+000	4009729057186

2
Years
Guarantee



NOVUS FloorStand 1000

- Floor stand for NOVUS TabletSafe
- High-quality, anodised aluminium column with internal cable guide and brushes to allow cables to protrude flexibly at any height
- Stylish metal base provides firm standing
- Ideal for using the TabletSafe in the showroom or shop window
- Moveable connect joint for holding the TabletSafe
- The connect joint provides a swivelling range of 360 degrees - with concealed cable routing, the tablet can be turned through +/- 45 degrees
- Angle of inclination at the connect joint can be adjusted to any position for an optimum viewing angle
- Height of the column: 1000 mm

Colours	Art.No.	EAN Code
 	882+1005+000	4009729061060
 	882+1009+000	4009729057193

2
Years
Guarantee



Tablet holder and accessories



NOVUS DeskMount

- Simple desktop stand for NOVUS TabletSafe
- Ideal for using the TabletSafe on the desk, table or counter
- With fixed angle of inclination of 55 degrees
- In high-quality metal with powder-coated finish

Colours	Art.No.	EAN Code
	882+0025+000	4009729057209



NOVUS WallMount

- Wall mount for attachment of the TabletCase and TabletSafe to the wall
- With fixed tilting angle of 33 degrees
- In high-quality metal with powder-coated finish

Colours	Art.No.	EAN Code
	882+0035+000	4009729057216



NOVUS TabletFix

- Universal, simple tablet holder
- For the use of different tablets of approx. 10 inches
- Mounting standard 100 x 100 and connect joint
- In high-quality metal with powder-coated finish

Colours	Art.No.	EAN Code
	881+3115+000	4009729066577



The right light in the right place.

Optimum lighting at every workstation – dimmable, and always exactly where the light is needed, thanks to the flexible, articulated arm.

Attenzia

The Red Dot Award 2018 in the product design category went to the NOVUS Attenzia space active HCL and the NOVUS Attenzia task.



reddot design award
winner 2018

Novus luminaires: ensuring your workstation is uniformly lit.

Novus luminaires provide optimum workstation lighting, creating the perfect conditions for more comfortable working.

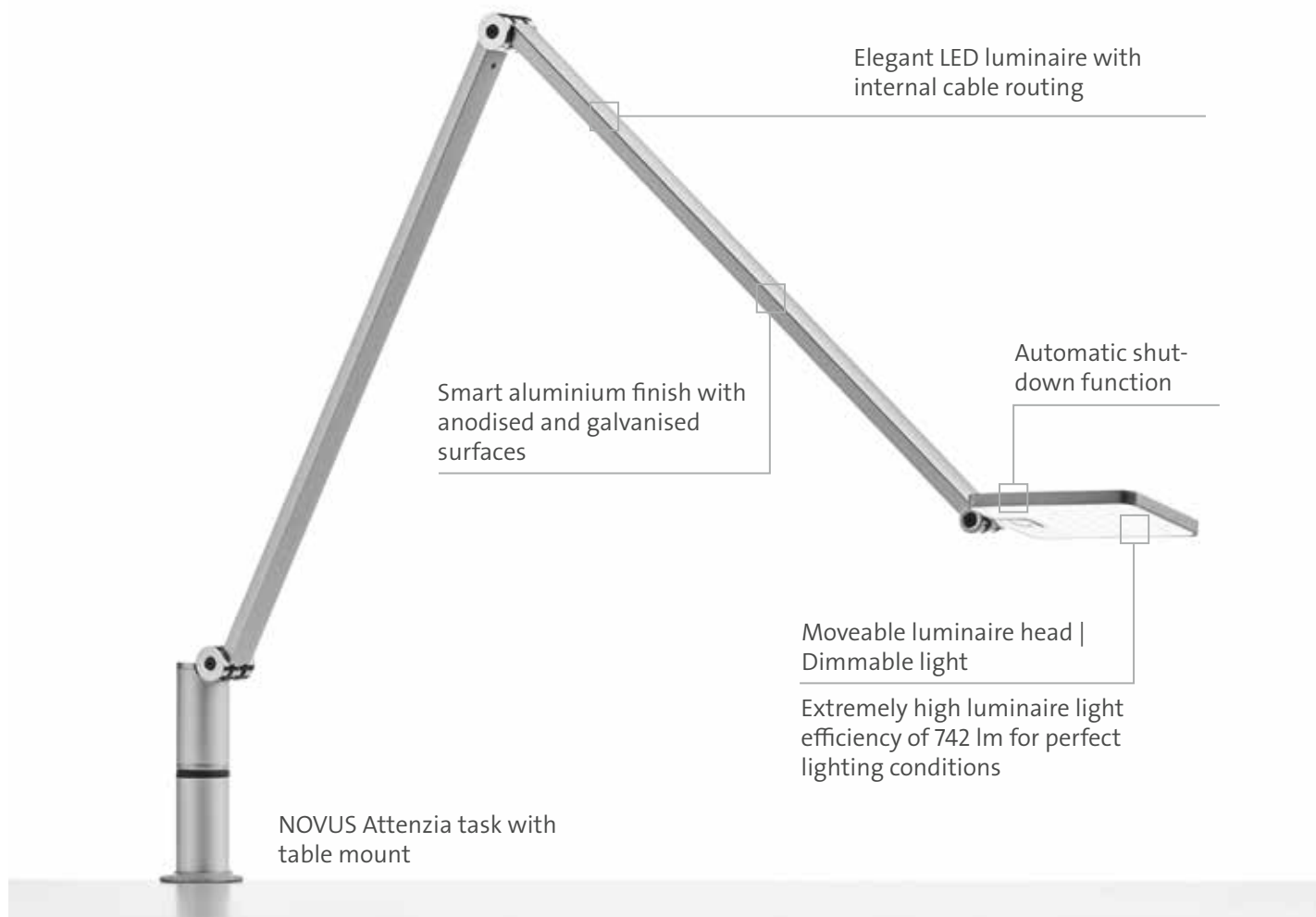

NOVUS Attenzia task:

As flexible as office requirements are variable. The Attenzia task's infinitely adjustable joints mean lighting can always be positioned perfectly.



NOVUS Attenzia task with base:

Light where it's needed. With the elegant, bright Attenzia task, your desk is always fully illuminated.

Alternative mounting systems.



Secure table mount with Attenzia clamp (available in two clamp lengths).



Attenzia rail system mount for use in various system rails offered by the office furniture industry.



Attenzia base plate: elegant and stable base for desks. Weight: 4 kg.

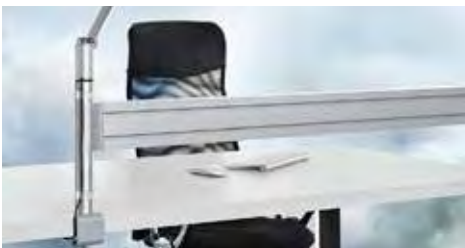

For use with MY columns (Ø 13 mm).



For use with TSS columns (Ø 16 mm).



Attenzia SlatWall-Adapter for mounting the luminaires on organisation walls.



Attenzia bushing: elegant insert sleeve for invisible cable management.



Attenzia cable port plastic: plastic cable guide for Ø 80 mm grommets with push-in adaptor for Ø 16-mm push-in studs (Attenzia TSS Version).















TSS push-in pin for Attenzia: pin adaptor for the Attenzia task and complete for mounting on TSS columns



NOVUS Attenzia task, without mount

- Smart LED desktop luminaire with slim-line 2-part aluminium support arm and internal cable routing
- The luminaire can be dimmed to any level and switches off automatically.
- Very high luminaire luminous flux of max. 742 lm for perfect illumination
- Extremely energy efficient at luminaire efficiency with 82,7 lm/W
- Excellent colour recognition with a high colour rendering index of 86 (>80)
- Large operating range: 1015 mm
- Cable length: approx. 2 m
- High-quality aluminium finish with anodised and galvanised surfaces (silver) and premium-quality painted surfaces in black and white
- This luminaire contains built-in LED lamps
- Luminaire suitable for light sources of energy classes A, A+ and A++
- Lamps cannot be replaced within the light

Colours	Art.No.	EAN Code
 	730+1201+000	4009729070659
 	730+1208+000	4009729070666
 	730+1209+000	4009729070673
 	740+1201+000	4009729062661
 	740+1208+000	4009729062685
 	740+1209+000	4009729061725







NOVUS Attenzia task, with TSS adaption

- Smart designed LED desk light with slim, 2-piece aluminium support arm to be mounted onto Novus TSS columns, equipped with Ø 16mm bolt

Consisting of:













- NOVUS Attenzia task
- NOVUS Attenzia TSS adaption pin

Colours	Art.No.	EAN Code
 	730+1209+001	4009729070680
 	740+1209+001	4009729063835



NOVUS Attenzia task, with base













- Smart LED desktop luminaire with slim-line 2-part aluminium support arm and internal cable routing
- Elegant desktop feet for placement on the desk
- Scale W 175 mm x H 19 mm x D 200 mm

Colours	Art.No.	EAN Code
 	730+1291+000	4009729070727
 	730+1298+000	4009729070734
 	730+1299+000	4009729070741
 	740+1291+000	4009729067574
 	740+1298+000	4009729067598
 	740+1299+000	4009729067611



NOVUS Attenzia task, with clamp 1





- Smart LED desktop luminaire with slim-line 2-part aluminium support arm and internal cable routing

Colours	Art.No.	EAN Code
 	730+1211+000	4009729070697
 	730+1218+000	4009729070703
 	730+1219+000	4009729070710
 	740+1211+000	4009729062678
 	740+1218+000	4009729062692
 	740+1219+000	4009729061732



Novus Attenzia complete, with Ø 13 mm bolt

- Smart designed LED desk-top luminaire with slim aluminium support arm and internal cable routing for illuminating the entire work space
- The luminaire can be dimmed to any level and switches off automatically.
- Extremely high luminaire light efficiency of max. 1708 lm for perfect lighting conditions
- Extremely energy efficient at luminaire efficiency with 83,3 lm/W
- Excellent colour recognition with a high colour rendering index of 86 (>80)
- Action radius: 726mm
- Cable length: approx. 2 m
- Classy aluminium finish with anodised and galvanised surfaces
- For fitting to a NOVUS MY column, supplied without mount
- This luminaire contains built-in LED lamps
- Luminaire suitable for light sources of energy classes A, A+ and A++
- Lamps cannot be replaced within the light
- Average illuminance E = 1714 LUX

Colours	Art.No.	EAN Code
 	730+2109+000	4009729070567
 	740+2109+000	4009729061961



MY base C MY base D MY base G MY base S

NOVUS MY base C, column

The obligatory column mounting for Attenzia complete

Column	Art.-Nr.	EAN-Nr.
MY base C MY column 350 mm, clamp 14-40 mm	911+0019+000	4009729052907
MY base C1 MY column 350 mm, clamp 13-25 mm	911+0029+000	4009729053867
MY base D MY column 350 mm, Bohrschraub-befestigung	911+0049+000	4009729052914
MY base G MY column 350 mm, Kabelloch-befestigung	911+0059+000	4009729052921
MY base S MY column 350 mm, Systemschienenbefestigung	911+0069+000	4009729052938















NOVUS Attenzia complete, with organisation wall mount

- Smart designed LED desk-top luminaire with slim aluminium support arm and internal cable routing for illuminating the entire work space
- The luminaire can be dimmed to any level and switches off automatically.
- Equipped with SlatWall adapter for organisation walls

Consisting of:

- NOVUS Attenzia complete
- NOVUS Attenzia SlatWall adapter

Colours	Art.No.	EAN Code
  3000 K	730+2171+000	4009729070581
  3000 K	730+2178+000	4009729070598
  3000 K	730+2179+000	4009729070604
  4000 K	740+2171+000	4009729068649
  4000 K	740+2178+000	4009729068656
  4000 K	740+2179+000	4009729068663







Novus Attenzia complete, with TSS adaption

- Smart designed LED desk-top luminaire with slim aluminium support arm and internal cable routing for illuminating the entire work space

Consisting of:



- NOVUS Attenzia complete
- NOVUS Attenzia TSS adaption pin

Colours	Art.No.	EAN Code
  3000 K	730+2109+001	4009729070574
  4000 K	740+2109+001	4009729063842

NOVUS Attenzia clamp 1 (1050 mm)

- Clamp for mounting on desktops
- Clamping length: 10-50 mm
- Suitable for NOVUS Attenzia task





Colours	Art.No.	EAN Code
	798+0011+000	4009729062708
	798+0018+000	4009729062715
	798+0019+000	4009729061695



NOVUS Attenzia clamp 2 (4585 mm)

- Clamp, especially for mounting on big desktops
- Clamping length: 45-85 mm
- Suitable for NOVUS Attenzia task



Colours	Art.No.	EAN Code
	798+0021+000	4009729062722
	798+0028+000	4009729062739
	798+0029+000	4009729061701







NOVUS Attenzia base

- Stable, elegant base for the desk
- Stable steel stand weighing 4kg
- Internal cable routing
- Dimensions: W 175 mm, H 19 mm, D 200 mm
- Suitable for NOVUS Attenzia task



Colours	Art.No.	EAN Code
	798+0031+000	4009729062746
	798+0038+000	4009729062753
	798+0039+000	4009729061718



NOVUS Attenzia system rail mounting

- System rail mount for use in various system rails from the office furniture industry
- Steel plate with aluminium casing

Colours	Art.No.	EAN Code
	798+0006+000	4009729063989





5
Years
Guarantee



NOVUS Attenzia SlatWall adapter

- SlatWall adapter to mount various products on organisation rails
- Suitable for organisation walls with 1 or 2 slots
- Compatible with Attenzia task and complete, and products with $\varnothing 13$ mm insertion pins

Colours	Art.No.	EAN Code
	798+0071+000	4009729064283
	798+0078+000	4009729064290
	798+0079+000	4009729064306

5
Years
Guarantee



NOVUS Attenzia bushing

- Metal insert sleeve for mounting the Attenzia task to the table
- For desktop thicknesses from 5 to 45 mm
- For bolts of $\varnothing 13$ mm
- Visible outer diameter of $\varnothing 35$ mm

Colours	Art.No.	EAN Code
	798+0008+000	4009729063422



5
Years
Guarantee





NOVUS Attenzia Wall Mount Adapter

- Adapter for wall mounting
- Compatible with Attenzia task and complete, and products with \varnothing 13 mm insertion pins

Colours	Art.No.	EAN Code
	798+0081+000	4009729067536
	798+0088+000	4009729067543
	798+0089+000	4009729067550

5
Years
Guarantee



NOVUS Attenzia TSS adaption pin

- Interchangeable pin adapter for the Attenzia task and complete for mounting on TSS columns
- \varnothing 16 mm bolt to be used with TSS columns
- Including TSS cover cap



Colours	Art.No.	EAN Code
	795+6061+000	4009729063859



5
Years
Guarantee



NOVUS Attenzia cable port plastic

- Plastic cable port for \varnothing 80 mm grommets with adapter for \varnothing 16 mm bolts
- For desktop thicknesses from 17 to 25 mm
- Suitable for the Attenzia task as well as for products with \varnothing 13 mm bolt



Colours	Art.No.	EAN Code
	796+0428+002	4009729065860
	796+0421+002	4009729065884

5
Years
Guarantee





Diverse accessories and storage options help create a tidy and cusotmised workstation for a better overview.



System for greater individuality
and more free space.





NOVUS PhoneMaster



- Compact design offering a high carrying capacity making it particularly suitable for larger and heavier-type telephones
- Table mounting with universal clamp 1 for a table thickness of 18-74 mm
- Swivelling around 360° for ease of movement
- Platform can be mounted crossways or lengthways
- Dimensions base plate: 258 x 172 mm

Colours	Art.No.	EAN Code
	713+0005+000	4009729019405
	713+0002+000	4009729019399



NOVUS ScopeMaster

- Smoothly telescoping swivel arm for positioning of devices in the third level
- Table mounting with universal clamp 1 for a table thickness of 18-74 mm
- Rotating support platform, inclined towards the user
- Swivelling around 360° for ease of movement
- Platform can be mounted crossways or lengthways
- Internal cable routing for optimum cable management
- Dimensions base plate: 258 x 172 mm

Colours	Art.No.	EAN Code
	714+0002+000	4009729019511
	714+0009+000	4009729042465



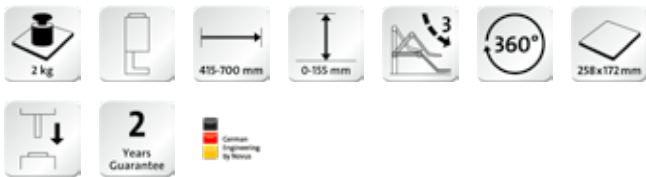

Office organisation universal support arms



NOVUS TalkMaster



- Telephone swivel arm with 2-part articulated arm for filing the phone in the third level
- Table mounting with universal clamp 1 for a table thickness of 18-74 mm
- 3-stage adjustment for flexible positioning
- Swivelling around 360° for ease of movement
- Platform can be mounted crossways or lengthways
- Dimensions base plate: 258 x 172 mm

Colours	Art.No.	EAN Code
	710+0005+000	4009729019160
	710+0002+000	4009729019153



NOVUS extension platforms



- Set of two extension plates to enlarge the support plate of universal support arms
- Increase the size of supporting platform from 258 x 172 mm to 258 x 258 mm or 258 x 344 mm
- Supplied with four clip connectors for easy assembling

Colours	Art.No.	EAN Code
	795+0905+000	4009729019627
	795+0902+000	4009729019610



NOVUS CopySwinger I



- Single tray for storage
- Plastic tray with practical recessed grip for ergonomic handling
- Table mounting with universal clamp 1 for a table thickness of 18-74 mm
- Swivelling around 360° for ease of movement
- Supplied with transparent label holder
- Expandable with other more space system products with universal clamp 1

Colours	Art.No.	EAN Code
	720+1005+000	4009729035412
	720+1002+000	4009729035429



NOVUS CopySwinger II

- Two trays among each other for a clearly arranged office organisation
- Plastic tray with practical recessed grip for ergonomic handling
- Table mounting with universal clamp 1 for a table thickness of 18-74 mm
- Swivelling around 360° for ease of movement
- Supplied with transparent label holder
- Expandable with other more space system products with universal clamp 1

Colours	Art.No.	EAN Code
	720+2005+000	4009729018545
	720+2002+000	4009729018538





Office organisation tray sets



NOVUS CopySwinger III



- Three trays among each other for the classic storage
- Plastic tray with practical recessed grip for ergonomic handling
- Table mounting with universal clamp 1 for a table thickness of 18-74 mm
- Swivelling around 360° for ease of movement
- Supplied with transparent label holder
- Expandable with other more space system products with universal clamp 1

Colours	Art.No.	EAN Code
	720+3005+000	4009729018583
	720+3002+000	4009729018576



NOVUS CopySwinger IV



- Four trays among each other offer lots of space
- Plastic tray with practical recessed grip for ergonomic handling
- Table mounting with universal clamp 1 for a table thickness of 18-74 mm
- Swivelling around 360° for ease of movement
- Supplied with transparent label holder
- Expandable with other more space system products with universal clamp 1

Colours	Art.No.	EAN Code
	720+4005+000	4009729018620
	720+4002+000	4009729018613



NOVUS CopySwinger V



- Five trays among each other offer much storage space
- Plastic trays with practical recessed grip for ergonomic handling
- Table mounting with universal clamp 1 for a table thickness of 18-74 mm
- Swivelling around 360° for ease of movement
- Supplied with transparent label holder

Colours	Art.No.	EAN Code
	720+5005+000	4009729018644
	720+5002+000	4009729018637



NOVUS CopySwinger Duo II

- Two sets of two trays about each other
- Plastic tray with practical recessed grip for ergonomic handling
- Table mounting with universal clamp 1 for a table thickness of 18-74 mm
- Swivelling around 360° for ease of movement
- Expandable with other more space system products with universal clamp 1

Colours	Art.No.	EAN Code
	721+4005+000	4009729018675
	721+4002+000	4009729018668



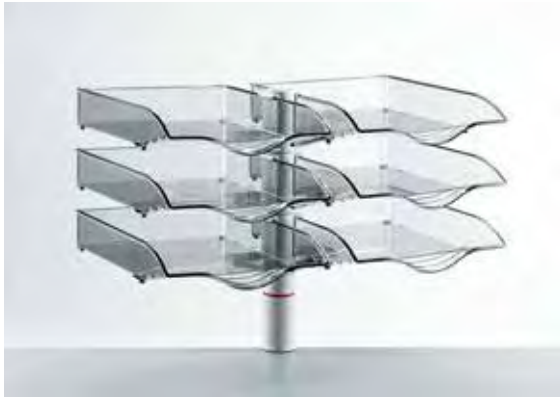

Office organisation tray sets



NOVUS CopySwinger Duo III

- Three sets of two trays about each other
- Plastic tray with practical recessed grip for ergonomic handling
- Table mounting with universal clamp 1 for a table thickness of 18-74 mm
- Swivelling around 360° for ease of movement
- Supplied with transparent label holder
- Expandable with other more space system products with universal clamp 1

Colours	Art.No.	EAN Code
	721+6005+000	4009729018712
	721+6002+000	4009729018705



NOVUS CopyTray, single tray

- Stackable and removable B4-single tray
- Plastic tray with practical recessed grip for ergonomic handling
- Supplied with transparent label holder

Colours	Art.No.	EAN Code
	720+0000+000	4009729018651



NOVUS label holder with paper for copy tray

- Plastic label holder with blank paper inserts for CopyTray storage tray

Colours	Art.No.	EAN Code
	420+2200+000	4009729027578











Product expires on 31.12.2020!



NOVUS BoardMaster base with supporting feet

- Practical shelves for perfect organisation of the workplace with desk-top feet
- Elegant desktop feet for placement on the desk
- Shelf depth: 195mm
- Available in length: 1000mm & 1200mm
- Expandable with other more space system products with universal clamp 1





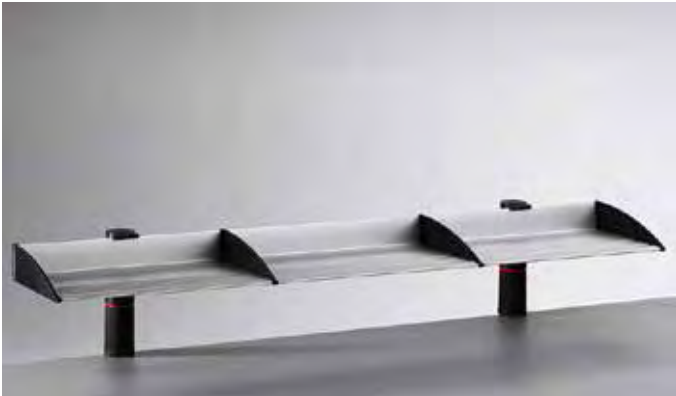



Colours	Art.No.	EAN Code
 	750+0555+000	4009729018774
 	750+0552+000	4009729018767
 	750+0655+000	4009729018811
 	750+0652+000	4009729018804

Office organisation trays and shelves



NOVUS BoardMaster with universal clamp 1

- Practical shelves for perfect organisation of the workplace for mounting at the desktop
- Table mounting with universal clamp 1 for a table thickness of 18-74 mm
- Shelf depth: 195mm
- Available in length: 1000mm & 1200mm
- Expandable with other more space system products with universal clamp 1



Colours	Art.No.	EAN Code
	 750+0505+000	4009729018750
	 750+0502+000	4009729018743
	 750+0605+000	4009729018798
	 750+0602+000	4009729018781



NOVUS ViewMaster-Fix

- Display pocket holders with 2-piece plastic joints in three automatic locking positions
- For 12 DIN A4 display pockets
- Table mounting with universal clamp 1 for a table thickness of 18-74 mm
- Range: 225 - 514 mm
- Rotating around 360°
- Display pockets can be fitted with indicator tabs to make information easier to find
- Display pockets are not included





Colours	Art.No.	EAN Code
	748+0005+000	4009729017869
	748+0002+000	4009729017852



NOVUS ViewMaster-Ergo II

- Display pocket holders with 2-part aluminium arm, adjustable plastic joints and spring balancing mechanism
- The infinitely adjustment ensures a comfortable presentation of information
- For 12 DIN A4 display pockets
- Table mounting with universal clamp 1 for a table thickness of 18-74 mm
- Range: 744 mm
- Swivelling around 360°
- NOVUS ScreenMount stand, base
- Display pockets are not included
- Display pockets can be fitted with indicator tabs to make information easier to find



Colours	Art.No.	EAN Code
	748+2002+000	4009729017838
	748+2009+000	4009729042441

Office organisation display pocket holders









2
Years
Guarantee



NOVUS display pockets

- Display pockets with swivel pins and plastic frame for DIN A4
- Open on one long side
- Delivery: individually packaged

Colours	Art.No.	EAN Code
	795+4811+000	4009729018279
	795+4804+000	4009729018248
	795+4801+000	4009729018224
	795+4808+000	4009729018262
	795+4806+000	4009729018255
	795+4812+000	4009729018286
	795+4802+000	4009729018231



2
Years
Guarantee



NOVUS indicator tabs

- Indicator tabs set
- Indicator tabs with printed paper inserts from A to Z
- Pluggable with transparent display
- Size: 25x20mm
- Including: 12 pieces



Colours	Art.No.	EAN Code
	795+4850+000	4009729018361

NOVUS offers a solution for every workspace situation. A big variety of mounting options for the more space range, eben for the lights.



NOVUS universal clamp 1, (1874 mm)

- Clamp for mounting on desktops
- Clamping length: 18-74mm
- Suitable for products with universal clamp 1

Colours	Art.No.	EAN Code
	795+0105+000	4009729019665
	795+0102+000	4009729019658



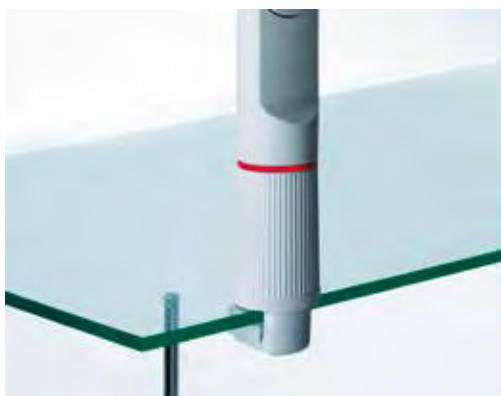

2
Years
Guarantee



NOVUS universal clamp 1, (864 mm)

- Clamp, especially for attachment to glass tables
- Clamping length: 8-64mm
- Suitable for products with universal clamp 1

Colours	Art.No.	EAN Code
	795+0155+000	4009729023402
	795+0152+000	4009729023396



2
Years
Guarantee





Office organisation additional fixations



Plastic screw-on

- Plastic screw-on plate for fixing in the table
- Fixing section: 51 mm
- Suitable for products with universal clamp 1



Colours	Art.No.	EAN Code
	795+1505+000	4009729019788
	795+1502+000	4009729019771

2
Years
Guarantee



Metal screw-on plate

- Robust metal screw-on plate for mounting in the desktop
- Fixing section: 51 mm
- Comes with metal screw sleeve
- Suitable for products with universal clamp 1



Colours	Art.No.	EAN Code
	795+1605+002	4009729029985
	795+1602+002	4009729032411

2
Years
Guarantee



NOVUS drilling screw fitting

- Drilling screw attachment for mounting on the table
- Drilling diameter: 14mm
- Suitable for products with universal clamp 1

Colours	Art.No.	EAN Code
	796+0345+000	4009729030394
	796+0342+000	4009729026441



2
Years
Guarantee





NOVUS wall mount metall standard

- Wall bracket for attachment to the wall, depending on the wall texture
- Suitable for products with universal clamp 1 or 2

Colours	Art.No.	EAN Code
	796+0849+000	4009729044704



NOVUS SlatWall adapter

- SlatWall adapter to mount various products on organisation rails
- Carrying capacity 8 Kg
- suitable for products, which are mounted with the universal clamp 1 or 2 and the LiftTEC monitor arms as well

Colours	Art.No.	EAN Code
	796+0839+001	4009729052549



NOVUS TSS column adapter

- Adapter for attaching various products to the TSS-column
- suitable for products, which are mounted with the universal clamp 1 or 2 and the LiftTEC monitor arms as well

Colours	Art.No.	EAN Code
	796+0829+000	4009729043851





Office organisation additional fixations



NOVUS plastic wall bracket



- Wall mount in plastic for attachment to the wall, depending on the wall texture
- Suitable for products with universal clamp 1

Colours	Art.No.	EAN Code
	795+2002+000	4009729019795
	795+2005+000	4009729019801



NOVUS height increase set

- Adapter for all office organisation products mounted with universal clamp 1
- Provides a greater distance between the work surface and a telephone support arm, a pen tray or a light
- Height increase by 124 mm
- suitable for products with universal clamp 1

Colours	Art.No.	EAN Code
	795+2125+000	4009729027158
	795+2122+000	4009729027141



NOVUS Pila: Novus seating balls make a stylish and ergonomic seat.

Movement keeps you fit! Thanks to the centre of gravity inside the Pila, the ball does not roll away and so always provides a clean, dust-free seat.

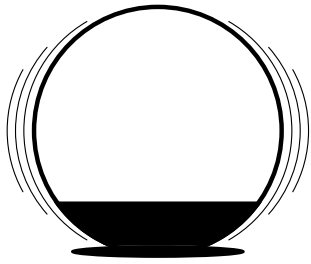

Balance Ball

The weight reinforcement inside means the ball is self-levelling.

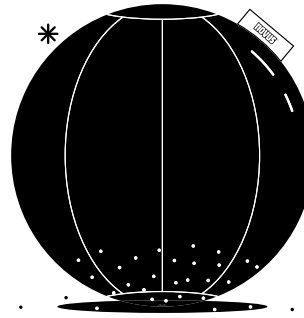

Dust-repellent seat

With the internal Balance Ball, you avoid getting your clothes dusty.

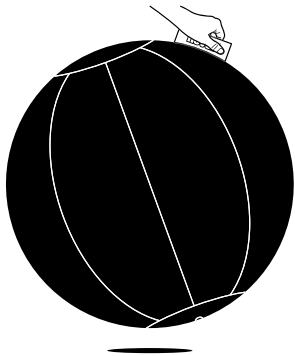

Functional label

Makes it easy to lift, carry and reposition the ball.

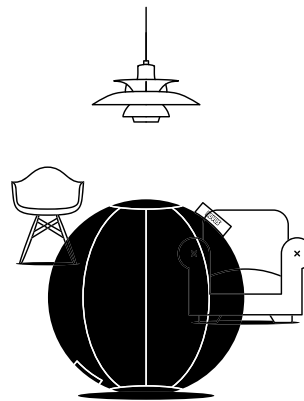

Clear design language

The ball's minimalist design means it fits right into modern open-space offices, too.

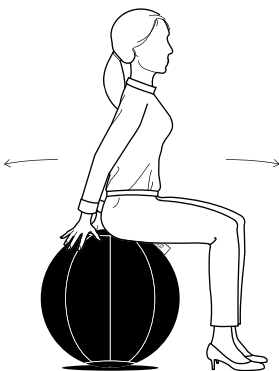

Ergonomic sitting

The ball's shape keeps you constantly moving.

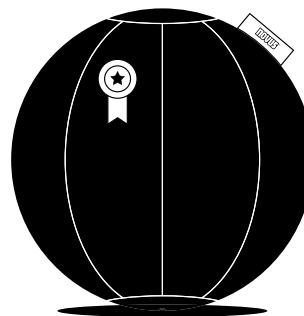

High-quality materials





A precisely constructed cover of imitation leather.



NOVUS Pila Brown Leather

- The shape of the NOVUS Pila seating ball makes it ideal for ergonomic sitting and it perfectly balances your movements. Dynamic sitting keeps you constantly moving and gives you strengthened and healthy back muscles.
- The internal weight reinforcement in the ball creates a centre of gravity, so that the NOVUS Pila seating ball is self-levelling. As a result, the ball does not roll away, and the seat remains dust and dirt free.
- The handy label makes it easy to lift, carry and reposition the NOVUS Pila seating ball.
- Thanks to its elegant, timeless and clear design, the NOVUS Pila seating ball fits into any furnishing style, whether in the office or in your own home office.
- The NOVUS Pila seating ball has a precisely constructed cover of high-quality imitation leather that is easy to remove and clean.
- Delivery includes a cover, a PVC inner ball, a manual air pump, 2 self-closing valves and a pump adapter for commercial air pumps.

NEW

Colours	Item no.	EAN
 	749+0656+000	4009729070758
 	749+0706+000	4009729070765



Mounting options



System clamp

Desktop mount with system clamp to mount the product without the need to drill holes in the desktop.



Ceiling mount

Ceiling mount lets you attach the product to the ceiling.



Attenzia clamp

Desktop mount for Attenzia lights to mount the product without the need to drill holes in the desktop.

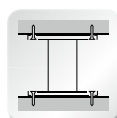

Ceiling/floor mount

Ceiling/floor mount lets you mount a column between ceiling and floor.



Drilling screw fitting

Drilling screw fitting to mount the product by drilling a hole in the desktop.



Wall mount

Wall mount lets you attach the product to the wall.



Cable port mount

Cable port mount ensures secure attachment on existing cable ports.



Floor stand

Sturdy stand for positioning on the floor.



Pin adapter

Desktop mounting with pin adapter (16 mm in diameter) is used in various desk adapters by the office furniture industry.

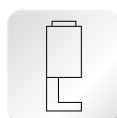

Universal clamp

Desktop mount with universal clamp 1 for desktops in a thickness of 18-74 mm.



System rail mount

System rail mount for use in various system rails from the office furniture industry.



Luma clamp

Desktop mount with luma clamp to mount the product without the need to drill holes in the desktop.



Desk stand

Elegant stand for positioning on the desk.

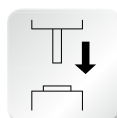

Combinability

All items with universal clamp 1 can be fitted to the product.



Attenzia base plate

Elegant base for positioning on the desk.



Organisation wall mount

Organisation wall mount to attach the products to an organisational wall by using slot nuts.



3-in-1 table mount

This table mount can be used as a clamp, grommet and drilling mount.

Technical specifications



Standard monitor mount

The standard mount to use with any monitor compatible with 75 x 75 mm or 100 x 100 mm attachment standard.

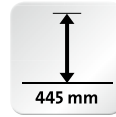

Column length

The value indicates the height of the column above the desk in mm.

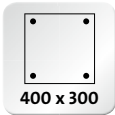

Monitor mount

This mount is to attach monitors compatible with the attachment standard given in mm. (The maximum possible standard is indicated.)



Height above desk

The value indicates the minimum and maximum distance between the product and desk surface.



Monitor weight

This value indicates the maximum load-bearing capacity of the supporting element or the maximum weight of a monitor in kg.

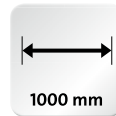

Width

The value indicates the width of the product in mm.



Carrying capacity

The weight shows the maximum weight in kg that the product is allowed to carry.



Range

The value indicates the product's range in mm.



Dimensions of support platform

The value indicates the size of the platform in mm.



Swivelling range

The value indicates the product's possible swivelling range in °.



Adjustability

The device is easily and infinitely adjustable, thanks to its patented spring balancing mechanism.

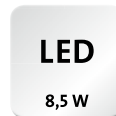

Power consumption

The value indicates the lamp used and the power consumption in watts.



Adjustability

The device can be clicked into three fixed positions.



Diameter

The value indicates the diameter of the Pila seating ball in cm.



Colour temperature

The value indicates the colour temperature in kelvins.



ENEC certified

This product meets the requirements of the EU General Product Safety Directive



German Engineering

The "German Engineering" quality mark guarantees that the product has been developed by our engineers in line with German quality standards. Production takes place in our own factories across the world, managed from Germany.



GS certified

TÜV Nord tested in accordance with the German Product Safety Act.

Novus & Dahle:

quality, functionality & design

under one roof.

For over seventy years, the emco Group in Lingen has stood for high-quality “German Engineering” and innovative product development. Today, with its four strong brands, emco, Novus, Dahle and emco e-scooter international, it operates successfully and internationally in a wide range of industries.

The Dahle and Novus brands are the experts for everything to do with office technology. Created to meet a wide variety of different workplace requirements, their diverse product ranges offer innovative details to make your daily working life that bit easier and more efficient – and all in an attractive design.

Novus is an expert in the business area of fastening technology, too. Here, the company supplies a reliable range of universal tackers and riveting tools for the home, hobby and professional sectors for a vast range of applications.



Novus staplers and perforators



Novus logo mats



Novus fastening technology



Dahle cutters



Dahle document shredders



Dahle presentation systems

Living and working with Novus Dahle.

Novus Dahle does everything it can to make work as pleasant and relaxed as possible for people in offices. That's why we don't limit ourselves to developing and producing state-of-the-art office technology but go above and beyond this.

In our social magazine, WorklifeExperts, you can find out more about the most important topics affecting office work: www.novus-dahle.com



855-2593 EN 03/20
Technical information and design are approximate and subject to change.

Novus Dahle GmbH
Breslauer Straße 34-38
49808 Lingen
GERMANY
Tel. +49 (0) 591/9140-0
Fax +49 (0) 591/9140-841
info@novus-dahle.com

www.novus-dahle.com



Part of the