



SAMSUNG

2024 MOUNTING SOLUTIONS



Field Service · Healthcare · Manufacturing · Public Safety · Retail · Transportation · Warehouse

National Products, Inc. | RAM® Mounts

The Connected Associate

There are many interpretations of what “The Connected Associate” looks like. Here at RAM® Mounts, we believe that The Connected Associate brings together the power of mobile devices, software, and accessories to enable an efficient workforce, all-in-one ecosystem of products. Our extensive ecosystem of enterprise-ready products has been carefully designed to support associates during every step of their workflow, including transportation and logistics, material handling, inventory tracking, item picking, and more. For decades, RAM® Mounts has helped thousands of companies keep their devices protected and charged, adopt safety standards, and ruggedize their mobility.



2



3



4



1

SEEN IN THESE PHOTOS:

1. RAM-GDS-SKIN-SAM78-NG

IntelliSkin® Next Gen for Samsung Tab S8+ and More

RAM-GDS-ROTO2U

GDS® Roto-Mag™ 3-in-1 Accessory

2. RAM-DOCK-6G-SAM84CPU

RAM® 6-Port Charging Dock for Samsung XCover6 Pro With RAM® Skin™

3. RAM-HOL-SAM52PD2U

RAM® Power & Dual USB Data Dock for Tab Active4 Pro & Tab Active Pro

RAM-KB4-USB

GDS® Keyboard™ with 10-Key Numeric Pad

4. RAM-GDS-SKIN-SAM78-NG

IntelliSkin® Next Gen for Samsung Tab S8+ and More

RAM-GDS-DOCKL-SAM78CPU

Locking GDS® Tough-Dock™ for Samsung Tab S8+, S7+ & S7 FE



6



7



5

SEEN IN THESE PHOTOS:

- 5. RAM-GDS-101B2-SAM62C-C-V7CU**
GDS® Tough-Dock™ Klein VALOR PTT Vehicle Bundle for Samsung Tab Active3
- 6. RAM-B-166-UN10U**
RAM® X-Grip® Large Phone Mount with Twist-Lock™ Suction Cup - Medium
- 7. RAM-B-101-225B2-SAM60P-V7B1U**
RAM® EZ-Roll'r™ Powered Mount for Samsung Tab Active5

The Ecosystem

RAM® Mounts designs and manufactures reliable docks and mounts that shield devices from damage, keep devices charged, and futureproof the entire solution by creating an ecosystem of products that work together seamlessly.



GDS® docking stations allow you to leverage Samsung DeX, transferring device functions to a desktop experience



Transfer the same devices to compatible RAM® docking stations for a wide variety of vehicles

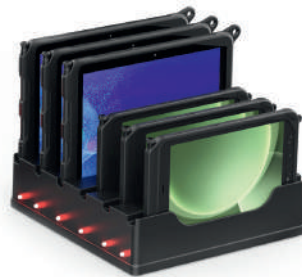

Multi-port docking stations keep devices charged overnight, reducing clutter and damage to charging ports



The Industry Standard

For over 30 years, National Products Inc. supplies the most rugged and connective mobile device mounting systems on the planet. With the globally recognized RAM® Mounts and award-winning GDS® Tech™, and IntelliSkin® product lines, NPI's mission to bring world-class mounting solutions to real-world applications have become essential to success in almost all industries—we are the industry standard.

SEEN IN THIS PHOTO:

RAM-101U-247

RAM® Universal Post Clamp Mount with Round Plate - C Size Medium Arm

RAM-HOL-SAM52PU

RAM® EZ-Roll'r™ Powered Dock for Tab Active4 Pro & Tab Active Pro

RAM-SKIN-SAM52-1

RAM® Skin™ for Samsung Tab Active4 Pro & Tab Active Pro

RAM-GDS-SS1U

GDS® Shoulder Strap Accessory for IntelliSkin® Products



Contents

- 6 | Case Studies
- 8 | Healthcare & Retail **NEW**
- 10 | Transportation
- 12 | Push-To-Talk **NEW**
- 14 | Material Handling & Inertia **NEW**
- 16 | Tab Active5 & Tab Active3 **NEW**
- 26 | Uni-Conn System **NEW**
- 28 | Desktop Docks
- 30 | Tab Active4 Pro
- 34 | Tab A Series
- 38 | Tab S Series **NEW**
- 42 | XCover6 Pro & XCover 5
- 44 | XCover Pro & FieldPro
- 50 | Universal Docks
- 56 | Universal Holders
- 60 | Future-Proofing
- 62 | GDS® Ergo™ Accessories
- 64 | Temperature Control
- 66 | DeX In-Vehicle
- 68 | Hardwire Chargers
- 70 | Care & Maintenance



Connective Longevity and RFID Compatibility with GDS® Tech™

One of the leading student transportation solution providers, First Student, has spent years curating the very best products to bring the Connected Highway vision to the education industry. In doing so, First Student has successfully transitioned thousands of districts all over the US to include centralized vehicle telematics and student tracking integrated into their buses. The entire workflow centers around in-cab tablets, tailored software, and RFID technology. In order to enable this new system, First Student enlists the help of RAM® Mounts, Samsung, and student tracking software like SMART tag™, TylerTech, and Edulog.



RAM-GDS-DOCKL-SAM62CP-NFCU
Locking GDS® Tough-Dock™ for Tab Active3 with RAM® NFC Extender

THE RAM® MOUNTS SOLUTION

In order for First Student to deploy telematics solutions, they needed secure vehicle docks with a reliable connection to power and peripherals. RAM® Mounts recommended the game-changing GDS® Tech™ system. Known for connective longevity, First Student noticed the GDS® system performed better than conventional mounting solutions. This was due to the protective and connective nature of a device wrapped with IntelliSkin®, the foundational component that enables the GDS® system to work. School buses being as dirty as they normally are, the IntelliSkin® protects the device's USB ports and converts the connection point to pogo pin contacts making it easier to clean and maintain charge upon docking. The second requirement from First Student was the ability to use RFID, or NFC peripheral devices to enable student tracking. Fortunately, GDS® Docks™ are modular and RAM® offers docking cups that allow for additional USB-A peripherals such as the SMART tag™ RFID reader, as well as RAM®'s patented NFC Extender. RAM® rounds off each solution with their famous, and customizable, double ball and socket mounts.

OUR PRODUCT SOLUTIONS



RAM-GDS-SKIN-SAM74-NG
IntelliSkin® Next Gen for Samsung Tab Active3



RAM-GDS-DOCKL-SAM62CP-NFCU
Locking GDS® Tough-Dock™ for Tab Active3 with RAM® NFC Extender



RAM-101-B-225B2U
RAM® Drill-Down Dashboard Mount with Backing Plate - C Size Short



RAM-GDS-CHARGE-V3C-2U
GDS® Modular 10-30V Power Delivery Hardwire Charger with Male USB Type-C



RAM-GDS-HS1U
GDS® Hand-Stand™ Hand Strap and Kickstand for Tablets



RAM-GDS-CAB-CLAMP1U
GDS® mUSB & Type-C Cable Clamp



RAM® Plays Pivotal Role in New High-Tech Recycling Smart Trucks

North America's largest recycler of post-consumer materials has developed groundbreaking automated recycling technology and successfully deployed it in thousands of its collection trucks across the continent. This innovative system utilizes artificial intelligence to identify and analyze recycling challenges, ultimately enhancing overall efficiency. Recent studies conducted by this organization and its affiliates have revealed that a significant majority of consumers express confusion regarding proper recycling practices, leading to the disposal of unusable mixed materials. With the advent of this state-of-the-art technology, the aim of this prominent recycling company is to eradicate any guesswork associated with recycling processes.



RAM-GDS-SKIN-SAM74-NG

IntelliSkin® Next Gen for Samsung Tab Active3

RAM-GDS-DOCK-SAM62CPU

GDS® Tough-Dock™ for Tab Active3

THE RAM® MOUNTS SOLUTION

When these smart trucks collect recyclables from customer bins, a cutting-edge system kicks into gear. Live cameras and sensors scan the materials, while the AI centralizes the data and uncovers opportunities for service improvements. Challenges include overfilled containers, bins not placed out for service, and incorrect recycling materials. For this system to work, each driver is equipped with a Samsung Tab Active3 and a RAM® Mounts docking solution. In this case, the large recycling organization needed a scalable solution and RAM®'s connective product line "GDS® Tech™ & IntelliSkin®" was the ideal choice to deploy in thousands of trucks. The goal was to ruggedize the system, keep devices charged, and connect the tablet to the vehicle's gateway where data from the AI program, as well as vehicle diagnostics, are stored.



Georgia-Pacific Keeps One Eye on Tomorrow

When Georgia-Pacific determined that new devices were necessary to run the latest software and security updates required for their manufacturing plants, they kept two characteristics in mind: flexibility and ease of updates. As a global leader, custom applications and solutions are needed to continue cutting-edge innovation.

THE RAM® MOUNTS SOLUTION

The GDS® Tech™'s standardized ecosystem is a future-proofed model that provides protection, charging, and data sync capabilities for fleets of devices. Our three-part system starts with a device-specific IntelliSkin® featuring MIL-STD-810H drop protection, ruggedized GDS® Tech™ pogo pads, and integrated USB Type-C connector. The integrated connection makes it simple to keep your devices powered while protecting the device ports from breakage due to constant plugging and unplugging.



RAM-GDS-SKIN-SAM54-NG-1

IntelliSkin® Next Gen for Samsung Tab Active4 Pro & Tab Active Pro

RAM-GDS-DOCK-SAM54CD2U

GDS® Tough-Dock™ + Dual USB for Samsung Tab Active4 Pro & Tab Active Pro

RAM-DIS-103-2AU

RAM® Standard Heavy Duty Accessory/Display Bracket

RAM-KB2-USB

GDS® Keyboard™ with Track Pad

RAM-101U

RAM® Double Ball Mount with Two Round Plates - C Size Medium

Coming Soon

GDS® Tech™ for Healthcare

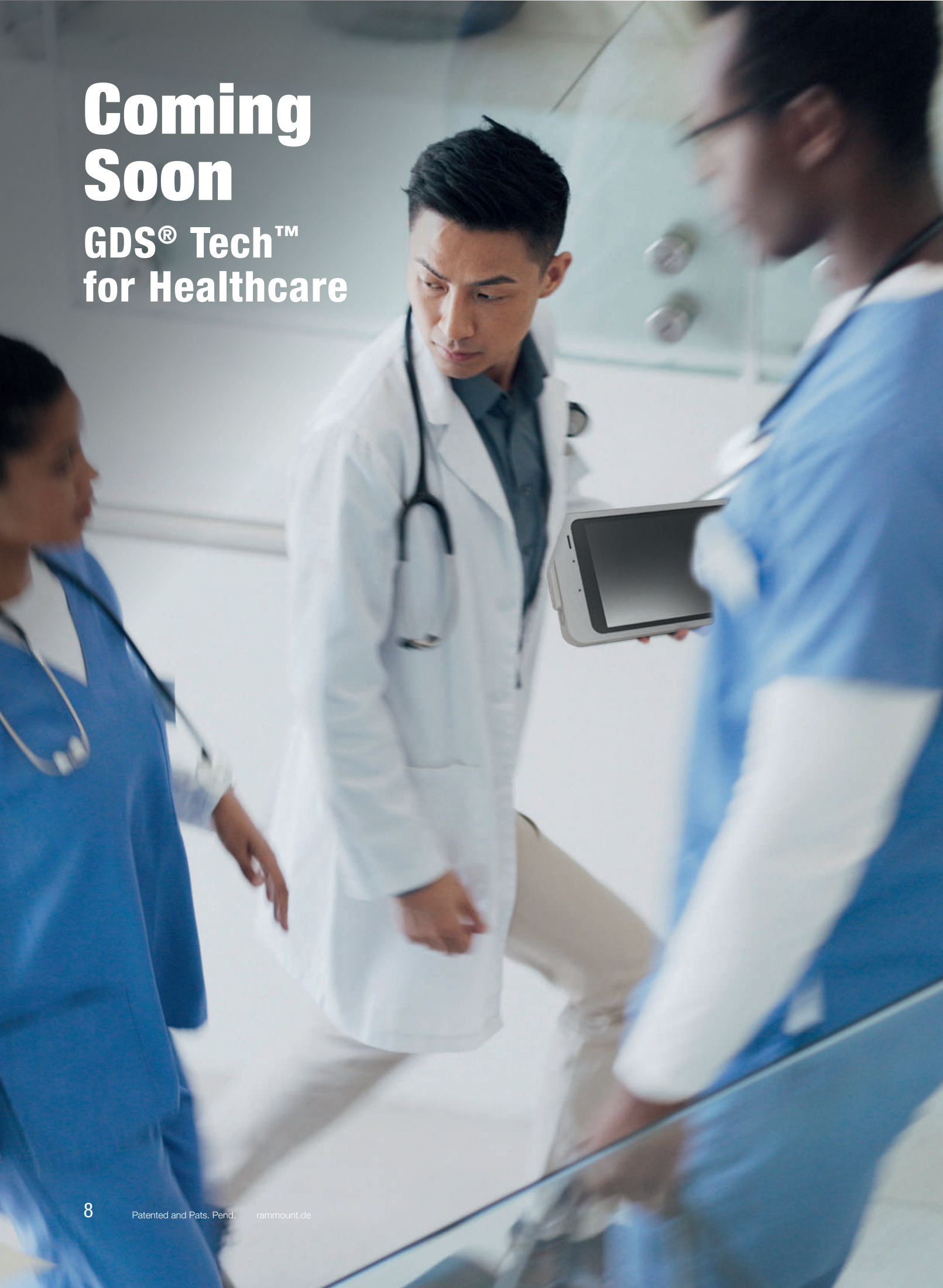

COMING SOON

Light Gray Collection

Seamlessly integrate your Samsung device into professional settings with RAM® Mount's sophisticated collection of Light Gray products, designed to compliment bright, clean retail, office, and medical environments. There's no need to sacrifice the carefully curated aesthetic of your business for the rugged, reliable features of GDS® Tech™ when you can have the best of both worlds!

Interested in custom colored products for your business?

Contact support@rammount.com

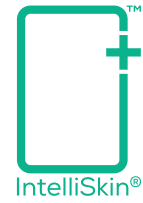

Industries

Transportation

For the last few decades, RAM® Mounts has collaborated with the industry's best innovators to build the future of mobility. The key to a mobile workforce combines device, software, and docking solution. Every day our engineering teams look for ways to optimize product performance to seamlessly integrate into one another, making the lives of drivers all around the world easier, and business logistics scalable. That's why RAM® offers turnkey, rugged, cost-effective mounting solutions for ELD compliance. Depending on what device you are deploying, RAM® will either have the right solution ready to go, or custom-build the right kit for you. Take advantage of upgrades like peripheral support, add-on accessories, and the award winning GDS® Tech™ for connective longevity and reliability.



SEE
◀ TRANSPORTATION
CATALOG



RAM® Tough-Case™ Bundles

Stays with the vehicle

This rugged two-piece enclosure creates a secure hardwired connection to support devices in No Battery Mode. With a coiled cable that can stretch extensively, users maintain limited mobility while enjoying a clutter-free, always-connected workspace.



RAM-101B2-TC-SAM29C-V3FCU
RAM® Tough-Case™ Power Delivery Bundle for Samsung Tab Active5 & 3



RAM-101B2-TC-SAM54C-V3FCU
RAM® Tough-Case™ Bundle for Tab Active4 Pro with Power Delivery Charger

Open enclosure on front and back allows heat to flow from device

Oversized strain relief protects cable connection and keeps device tethered to vehicle



RAM® EZ-Roll'r™

Stays with the user

Designed to meet the demands of field workers, the RAM® EZ-Roll'r™ is ideal for those who need to grab their tablet and go. Once their task is complete, workers can effortlessly dock their devices and get a quick charge between job sites.



RAM-B-101-225B2-SAM60P-V7B1U
RAM® EZ-Roll'r™ Powered Mount for Samsung Tab Active5 and Tab Active3



RAM-101-B2-SAM52P-V7B1U
RAM® Powered Mount for Samsung Tab Active4 Pro with Backing Plate

Access to speakers, mics, and headphone jack remain while device is docked



Powered cradle provides charging capabilities for device through integrated pogo pins

SEEN IN THIS PHOTO:

RAM-B-101-225B2-SAM60P-V7B1U
RAM® EZ-Roll'r™ Powered Mount for Samsung Tab Active5 & Tab Active3

Push-To-Talk

When your team hits the road, reliable communication is a non-negotiable in keeping them safe and up-to-date. The GDS® Push-To-Talk (PTT) vehicle bundles seamlessly keep your devices protected, connected, and charged so your team can focus on the task at hand.

Compatible software providers:

ES Chat, Zello, Tassta, Motorola, Airbus Tactilon Agent, Microsoft Teams Walkie Talkie (certified partner/certified headsets), Unity Intercom, AT&T: EPTT, T-Mobile: Direct Connect

WORLD'S FIRST

Push-To-Talk via USB Type-C solution, made in partnership with Klein Electronics

[LEARN MORE](#)

FEATURE PRODUCTS:

RAM-GDS-U1-SAM90-KIT4
GDS® Uni-Conn™ Klein VALOR PTT Vehicle Bundle for Samsung Tab Active5

RAM-GDS-U1-SAM90-KIT3
GDS® Cable Clamp for USB Type-C Klein PTT Mic Adapter



IntelliSkin® has a USB-C port so that workers can plug their microphone in as needed

LOW-PROFILE DOCKS FOR TAB ACTIVE5 & TAB ACTIVE3

PART NUMBER	DEVICE	DOCK TYPE	MIC TYPE
RAM-GDS-101B2-SAM80-PTT1U	Tab A7 Lite 8.7"	Tough-Dock™	Universal PTT mic - Included
RAM-GDS-101B2-SAM80C-C-V7CU	Tab A7 Lite 8.7"	Tough-Dock™	Klein VALOR mic - Not included
RAM-GDS-101B2-SAM62-PTT1U	Tab Active3	Tough-Dock™	Universal PTT mic - Included
RAM-GDS-101B2-SAM62C-C-V7CU	Tab Active3	Tough-Dock™	Klein VALOR mic - Not included
RAM-GDS-U1-SAM90-KIT3	Tab Active5	Uni-Conn™	Universal PTT mic - Included
RAM-GDS-U1-SAM90-KIT4	Tab Active5	Uni-Conn™	Klein VALOR mic - Not included

Push-To-Talk



SEEN IN THIS PHOTO:





RAM-GDS-101B2-SAM62C-C-V7CU
GDS® Tough-Dock™ Klein VALOR PTT
Vehicle Bundle for Samsung Tab Active3

Material Handling & Inertia

Distracted driving causes accidents. With Samsung Intertia, device screens remains blank while in motion until drivers come to a complete stop. Pair this software-based safety measure with a secure mounting solution from RAM® Mounts to keep devices in-view without obstructing the driver's field of vision.

OUR PICK

Tab Active4 Pro

TABLET + KEYBOARD KIT

RAM-GDS-SKIN-SAM54-NG-1 IntelliSkin® Next Gen for Samsung Tab Active4 Pro & Tab Active Pro

RAM-GDS-DOCK-SAM54CD2U GDS® Tough-Dock™ + Dual USB-A for Tab Active4 Pro & Tab Active Pro

RAM-KB2-USB GDS® Keyboard™ with Track Pad

RAM-D-247-C-254-DIS1U RAM® Universal Forklift Post Mount with Round Plate & Accessory Option



Multi-touch, two-finger-capable trackpad

Backlit keypad with red illumination reduces eye strain

Keyboard mount can be angled for optimal user wrist comfort

Slotted holes on backing plate allow for cable retention

D-size ball mount supports the weight of tablet and keyboard

CHARGERS

10-30 VDC FOR PROPANE VEHICLES
RAM-GDS-CHARGE-V7CU GDS® Modular 10-30V Hardwire Charger with Male USB Type-C
30-64 VDC FOR ELECTRIC FORKLIFTS
RAM-GDS-CHARGE-V8CU GDS® Modular 30-64V Hardwire Charger with Male USB Type-C



Learn more about Inertia

[WATCH VIDEO](#)

Safety Standards

RAM® Mounts makes it easier to comply with local, federal, and international forklift safety standards to keep your workers safe while on the job.



Tab Active4 Pro

TABLET KIT

<p>RAM-GDS-SKIN-SAM54-NG-1 IntelliSkin® Next Gen for Samsung Tab Active4 Pro & Tab Active Pro</p>

<p>RAM-GDS-DOCK-SAM54CD2U GDS® Tough-Dock™ + Dual USB-A for Tab Active4 Pro & Tab Active Pro</p>

<p>RAM-101U-247 RAM® Universal Post Clamp Mount with Round Plate - C Size Medium Arm</p>



CHARGERS

<p>10-30 VDC FOR PROPANE VEHICLES</p>
<p>RAM-GDS-CHARGE-V7CU GDS® Modular 10-30V Hardwire Charger with Male USB Type-C</p>
<p>30-64 VDC FOR ELECTRIC FORKLIFTS</p>
<p>RAM-GDS-CHARGE-V8CU GDS® Modular 30-64V Hardwire Charger with Male USB Type-C</p>

Tablets

RAM® Skin™ for Tab Active5, Tab Active4 Pro, and Tab Active3

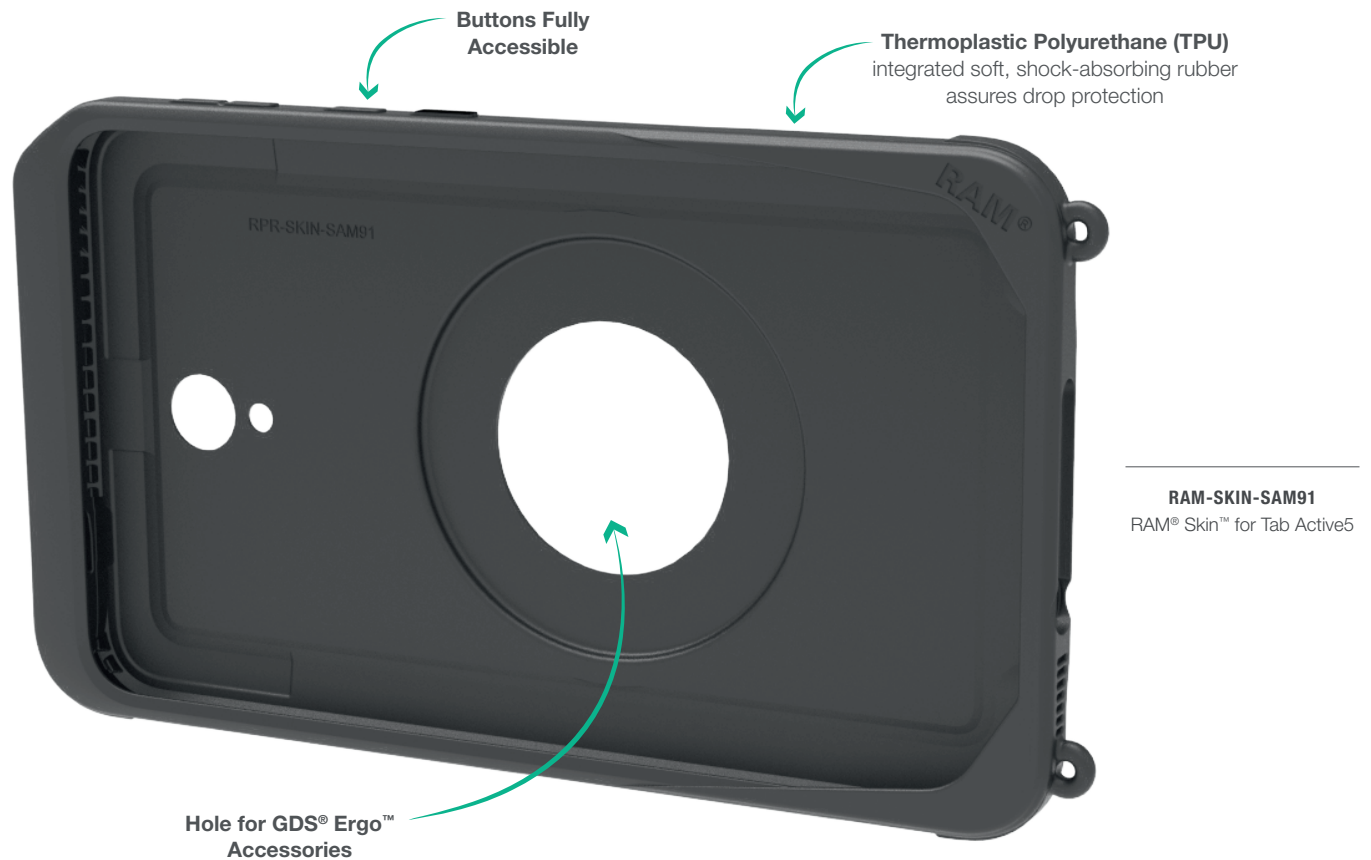
The RAM® Skin™ is a form-fit, protective sleeve that equips your device with an outerlayer of thermoplastic polyurethane for drop protection in rugged work environments. This case provides drop protection, giving you peace of mind as you invest in new devices for your workforce. The RAM® Skin™ is available for all Tab Active tablets, including the Tab Active5, Tab Active4 Pro, and Tab Active3.



Compatible GDS® Ergo™ Accessories



RAM-GDS-HS1U
GDS® Hand-Stand™ Hand Strap and Kickstand for Tablets



RAM-GDS-HS1MU
GDS® Hand-Stand™ Magnetic Hand Strap and Kickstand for Tablets



RAM-GDS-SS1U
GDS® Shoulder Strap Accessory

TABLETS CONTINUED

RAM® Skin™



SEEN IN THIS PHOTO:

RAM-SKIN-SAM52-1
RAM® Skin™ for Samsung
Tab Active4 Pro & Tab Active Pro



SEEN IN THIS PHOTO:

RAM-SKIN-SAM73
RAM® Skin™ for
Samsung Tab Active3



RAM-SKIN-SAM52-1

RAM® Skin™ for Samsung Tab Active4 Pro & Tab Active Pro



RAM-SKIN-SAM73

RAM® Skin™ for Samsung Tab Active3

SEE PG.18 FOR COMPATIBLE DOCKS FOR TA5 & 3

SEE PG.32 FOR COMPATIBLE DOCKS FOR TA4

Form-Fit Docks for Tab Active5 & Tab Active3

For a slim, clean mounting solution, form-fit holders offer a custom housing that perfectly fits the Samsung Galaxy Tab Active5 and Tab Active3 in its original OEM skin or the RAM® Skin™. Numerous add-ons and options include combination locks, key locks, dual USB, and a no-frills, power-only dock.

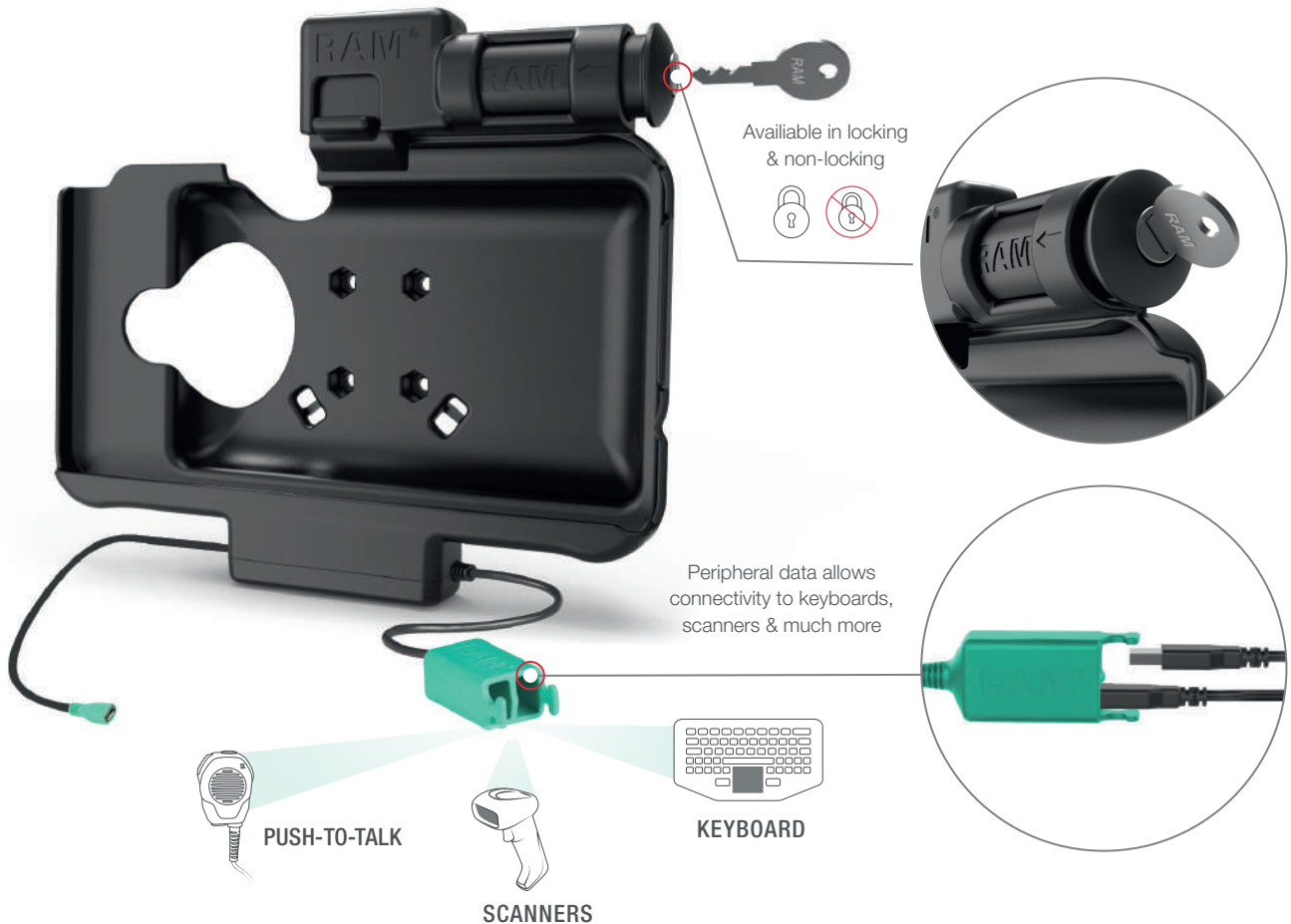

RAM-HOL-SAM60PU
RAM® EZ-Roll'r™ Powered Dock for Samsung Tab Active5 and Tab Active3



RAM-HOL-SAM58PDKLU
RAM® Key Locking Power + Data Dock for Samsung Tab Active5 and Tab Active3



RAM-HOL-SAM58PD2KLU
RAM® Key Locking Power + Dual USB Dock for Samsung Tab Active5 and Tab Active3

TABLETS CONTINUED

Form-Fit Docks



SEEN IN THIS PHOTO:

RAM-HOL-SAM60PU

RAM® EZ-Roll'r™ Powered Dock for Samsung Tab Active5 and Tab Active3

Compatible GDS® Ergo™ Accessories



RAM-GDS-HS1U

GDS® Hand-Stand™ Hand Strap and Kickstand for Tablets



RAM-GDS-HS1MU

GDS® Hand-Stand™ Magnetic Hand Strap and Kickstand for Tablets



RAM-GDS-SS1U

GDS® Shoulder Strap Accessory

FORM-FIT DOCKS FOR TAB ACTIVE5 & TAB ACTIVE3

PART NUMBER	POWER	KEY LOCKING	SINGLE USB PERIPHERAL	DUAL USB PERIPHERAL
RAM-HOL-SAM60PU	mUSB			
RAM-HOL-SAM58PKLU	mUSB	•		
RAM-HOL-SAM60PDU	mUSB		USB-A	
RAM-HOL-SAM60PD2U	mUSB			(2) USB-A
RAM-HOL-SAM58PKLU	mUSB	•	USB-A	
RAM-HOL-SAM58PD2KLU	mUSB	•		(2) USB-A
RAM-HOL-SAM60CPU	USB-C			
RAM-HOL-SAM60CP-CU	USB-C		USB-C	
RAM-HOL-SAM60CP-CAU	USB-C			USB-A & USB-C

SEEN IN THIS PHOTO:

RAM-HOL-SAM58PDTU
 RAM® Low-Profile Power +
 Single USB Dock for Tab Active3

TABLETS CONTINUED

Low-Profile Docks for Tab Active5 & Tab Active3

Our low-profile docks for Samsung Tab Active5 are constructed with a metal reinforcement plate on the back, allowing for a dramatic reduction in the dock's overall footprint to feature a total depth of 2.28". Power capabilities from the dock are provided to the device through pogo pin technology and integrated mUSB cable, taking advantage of the Tab Active5's integrated pogo pad docking contacts.

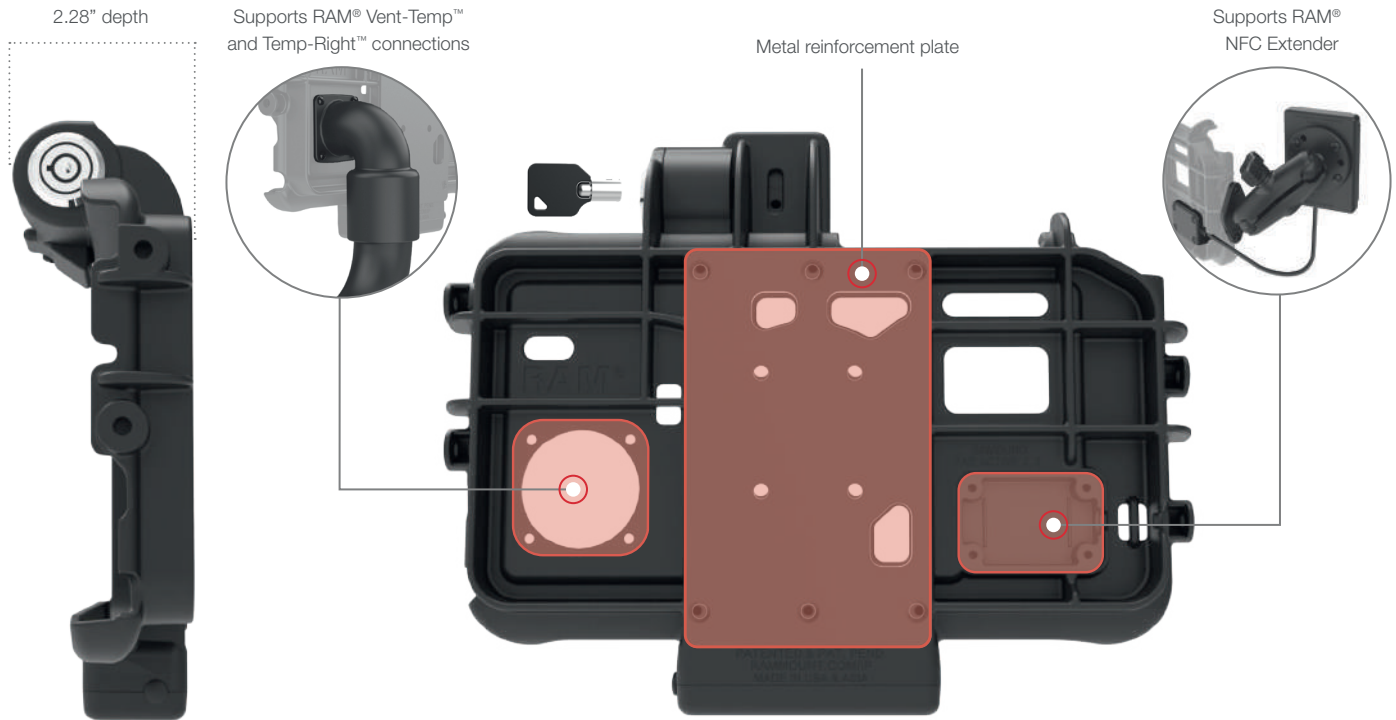

LOW-PROFILE DOCKS FOR TAB ACTIVE5 & TAB ACTIVE3

PART NUMBER	POWER	KEY LOCKING	SINGLE USB PERIPHERAL	DUAL USB PERIPHERAL
RAM-HOL-SAM58PTU	mUSB			
RAM-HOL-SAM58PDTU	mUSB		USB-A	
RAM-HOL-SAM58PD2TU	mUSB			(2) USB-A
RAM-HOL-SAM58PKLTU	mUSB	•		
RAM-HOL-SAM58PDKLTU	mUSB	•	USB-A	
RAM-HOL-SAM58PD2KLTU	mUSB	•		(2) USB-A
RAM-HOL-SAM58CPT-CAU	USB-C			USB-A & USB-C

Modular Docks for Tab Active5 & Tab Active3

The RAM® Modular Powered Dock series for the Samsung Tab Active5 is thoughtfully designed to meet the demands of commercial truck drivers, field service technicians, pupil transporters, logistics managers, forklift operators, and more. Power capabilities through the dock are provided to the device through pogo pin technology, taking advantage of the Tab Active5's integrated pogo pad docking contacts— simply dock the device for a seamless charging experience.

Supports RAM® Vent-Temp™ and Temp-Right™ connections

Available in locking & non-locking

AMPS mounting pattern

Side hole patterns support accessory mounting including RAM® NFC Extender



Back cavity accommodates ergonomic accessories, including the GDS® Roto-Mag™

Peripheral data allows connectivity to keyboards, scanners, and much more

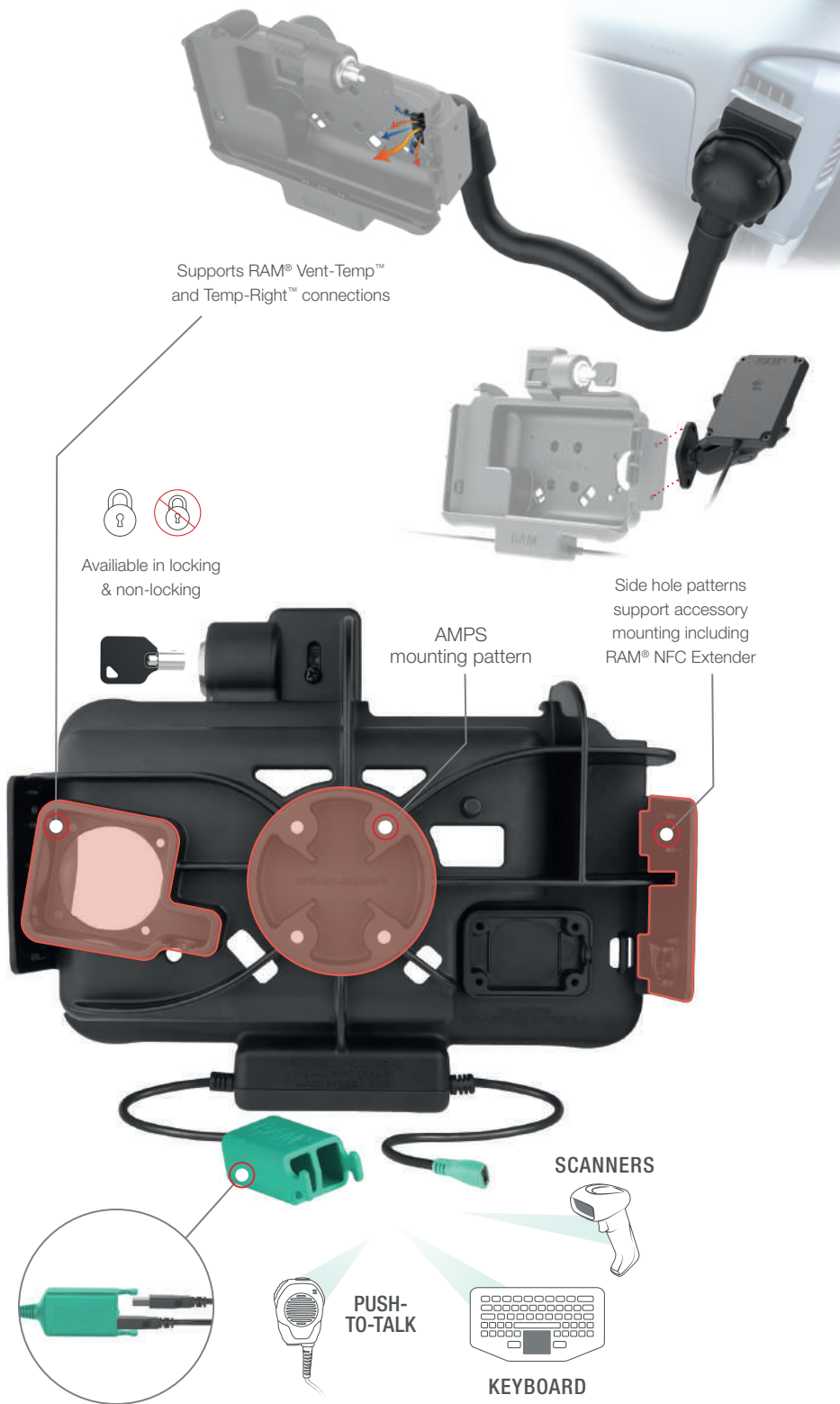

MODULAR DOCKS FOR TAB ACTIVE5 & TAB ACTIVE3

PART NUMBER	POWER	KEY LOCKING	NON-LOCKING	SINGLE USB PERIPHERAL	DUAL USB PERIPHERAL
RAM-HOL-SAM60PNU	mUSB		•		
RAM-HOL-SAM60PDNU	mUSB		•	USB-A	
RAM-HOL-SAM60PD2NU	mUSB		•		(2) USB-A
RAM-HOL-SAM58PKLNU	mUSB	•			
RAM-HOL-SAM58PDKLNU	mUSB	•		USB-A	
RAM-HOL-SAM58PD2KLNU	mUSB	•			(2) USB-A
RAM-HOL-SAM60CPN-CAU	USB-C		•		USB-A & USB-C
RAM-HOL-SAM58CPKLN-CU	USB-C	•		USB-C	
RAM-HOL-SAM58CPKLN-CAU	USB-C	•			USB-A & USB-C



OtterBox uniVERSE Docks

In collaboration with Samsung and OtterBox, RAM® Mounts has designed form-fit powered docks for the Samsung Galaxy Tab Active3 featuring uniVERSE compatibility. These docks come in single and dual USB peripheral support—turning your Tab Active3 into a mobile workstation when paired with a GDS® Keyboard™, printer, scanner gun, and more via USB Type-A connectors. Equipped with an OtterBox uniVERSE accessory holder, store and connect uniVERSE modules like the GPS Spike or Square Chip Reader Adapter for an efficient workflow.



RAM-DOCK-6G8P-0T1U

RAM® 6-Port Dock for Tab Active4 Pro & Tab Active3 with OtterBox uniVERSE



RAM-HOL-SAM60PD2-0T1U

RAM® Power + Dual USB Dock for Tab Active3 with OtterBox uniVERSE



RAM-HOL-SAM60PD-0T1U

RAM® Power + Data Dock for Tab Active3 with OtterBox uniVERSE



RAM-HOL-SAM60P-0T1U

RAM® Powered Dock for Tab Active3 with OtterBox uniVERSE

FEATURES



RAM® EZ-Roll'r™ form-fit dock perfectly secures the Tab Active3 with OtterBox uniVERSE making insertion and removal easy

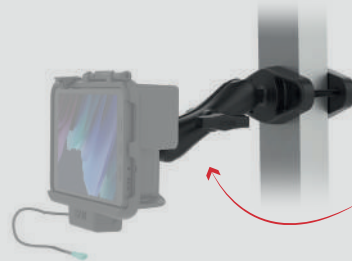

Compatible with RAM® 4-hole AMPS pattern bases for attaching a double socket arm; ball and socket technology allows for near-infinite adjustability



Integrated pogo pin contacts provide charging power to the device and protects the device's ports from constant plugging and unplugging



These docks include an integrated OtterBox uniVERSE accessory holder on the back of the holder to accommodate any accessory with a uniVERSE module. The additional cavity in the back of the dock allows room for the GDS® Hand-Stand™ and shoulder strap accessories



SEEN IN THIS PHOTO:

RAM-HOL-SAM61PU

RAM® Powered Dock for Tab Active5 & 3 with Speaker Box

Powered Docks with Integrated Speaker

Featuring integrated dual speakers for amplified audio, these powered docks for the Samsung Tab Active5 & 3 maintain all the same capabilities as the other RAM® EZ-Roll'r™ powered docks, including single and dual USB peripheral support and S pen accessibility. With the built-in hardwire charger, power capabilities are provided to the device through pogo pins. Pair these docks with any RAM® components that utilize the universal AMPS hole pattern.



RAM-HOL-SAM61PU

RAM® Powered Dock for Tab Active5 & 3 with Integrated Speaker



RAM-HOL-SAM61PDU

RAM® Power + Data Dock for Tab Active5 & 3 with Integrated Speaker



RAM-HOL-SAM61PD2U

RAM® Power + Dual USB Dock for Tab Active5 & 3 with Integrated Speaker



Integrated dual speakers on the bottom of the dock for amplified audio have a max volume level of 103dB @ 100mm

IntelliSkin® NG for Tab Active5 & Tab Active3

The IntelliSkin with GDS® Tech™ platform provides protection, charging, and data sync capabilities across a wide range of electronic devices, making it a perfect solution for fleet deployment. With GDS® Compatible™ IntelliSkin® protective sleeves, GDS® Docks™, and GDS® Ecosystem™ accessories, simplify the process of scaling and upgrading devices while taking advantage of a standardized charging and data transfer ecosystem.



COMPTABLE GDS® DOCKS™ FOR TAB ACTIVE5 & TAB ACTIVE3 INTELLISKIN® NG

PART NUMBER	POWER	KEY LOCKING	SINGLE USB PERIPHERAL	DUAL USB PERIPHERAL	ADDITIONAL INFORMATION
RAM-GDS-DOCK-SAM62CPU	USB-C 2.0				
RAM-GDS-DOCKF-SAM62CPU	USB-C 2.0				Built-in Fan NFC Extender
RAM-GDS-DOCK-SAM62CP-NFCU	USB-C 2.0				
RAM-GDS-DOCK-SAM62CDU	USB-C 2.0		USB-A		
RAM-GDS-DOCK-SAM62-MMU	USB-C 2.0		USB-A		Multi-Mode
RAM-GDS-DOCK-SAM62CD2U	USB-C 2.0			(2) USB-A	
RAM-GDS-DOCK-SAM62C-CU	USB-C 2.0		USB-C		
RAM-GDS-DOCKL-SAM62CPU	USB-C 2.0	•			
RAM-GDS-DOCKLF-SAM62CPU	USB-C 2.0	•			Built-in Fan NFC Extender
RAM-GDS-DOCKL-SAM62CP-NFCU	USB-C 2.0	•			
RAM-GDS-DOCKL-SAM62CDU	USB-C 2.0	•	USB-A		
RAM-GDS-DOCKL-SAM62CD2U	USB-C 2.0	•		(2) USB-A	
RAM-GDS-DOCK-SAM62CU	USB-C 3.1				
RAM-GDS-DOCKF-SAM62CU	USB-C 3.1				Built-in Fan
RAM-GDS-DOCKL-SAM62CU	USB-C 3.1	•			

GDS® Tough-Dock™ for Tab Active5 & Tab Active3

The GDS® Tough-Dock™ is a rugged, modular frame for IntelliSkin®-wrapped devices that are highly customizable to your business needs. These docks are key to the GDS® Reach™ experience— standardized charging, data transfer, and simplified scaling.



GDS® Uni-Conn™ Docks One Dock to Connect Them All™

The GDS® Uni-Conn™ is the newest innovation from RAM® Mounts, utilizing a universal docking platform. An attachable button adapter is the only component needed to transform an IntelliSkin® protective case into a revolutionary, low-profile docking station that eliminates the hassle of costly device upgrades. Not only is upgrading easy, but docking is too. With a button adapter installed, simply place the IntelliSkin®-wrapped device into the dock and push to snap into place. When undocking, a simple push of the lever releases the tablet, all with one hand. When considering your next device upgrade, there truly is only One Dock to Connect Them All™.

RAM-GDS-U1U
GDS® Uni-Conn™
Adapter for IntelliSkin®

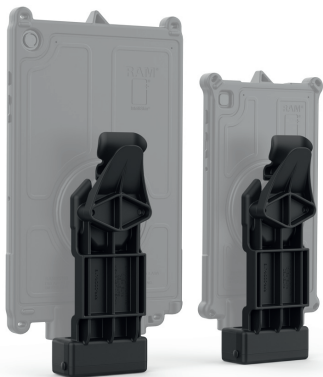

Seamless device upgrades for the future

Each IntelliSkin® is designed with the alignment point at the same height to connect with one universal docking station. When the time comes to upgrade devices in your fleet, a new IntelliSkin® is all that is needed. *NOTE: failure to install dock lever stop will void warranty.*



GDS® Uni-Conn™ Adapter for IntelliSkin®

Unlock the potential of GDS® Uni-Conn™ by installing the universal button adapter (**RAM-GDS-U1U**) to the back of your IntelliSkin®.



Spring-Loaded for Backwards Compatibility

For most IntelliSkin®-wrapped tablets outside of the listed compatible devices, a spring-loaded version of the GDS® Uni-Conn™ dock is available so you can implement this solution ahead of your next device upgrade.

Compatible IntelliSkin® NG Wrapped Devices for Uni-Conn™ Docks

These IntelliSkin® are Compatible with the Uni-Conn™ Docking System



Tab A7 Lite



Tab A 8.4



Tab S9 FE



Tab S9 FE+



Tab Active5



Tab Active3



Tab A9+

COMPATIBLE UNI-CONN™ DOCKS

PART ID	POWER	LOCKING	DATA
RAM-GDS-DOCKL-V12-U1CPU	•	•	
RAM-GDS-DOCKL-V12-U1CPDU	•	•	USB-A
RAM-GDS-DOCKL-V12-U1CPDHU	•	•	USB-A with Heated Pins
RAM-GDS-DOCK-U1U	•		
RAM-GDS-DOCK-U1CPU	•		
RAM-GDS-DOCK-U1CDU	•		USB-A
RAM-GDS-DOCK-U1CD2U	•		Dual USB-A

Compatible Accessories



RAM-GDS-U1HSU
GDS® Hand Strap with
Uni-Conn™ Adapter



LOCKING OPTIONS
COMING SOON

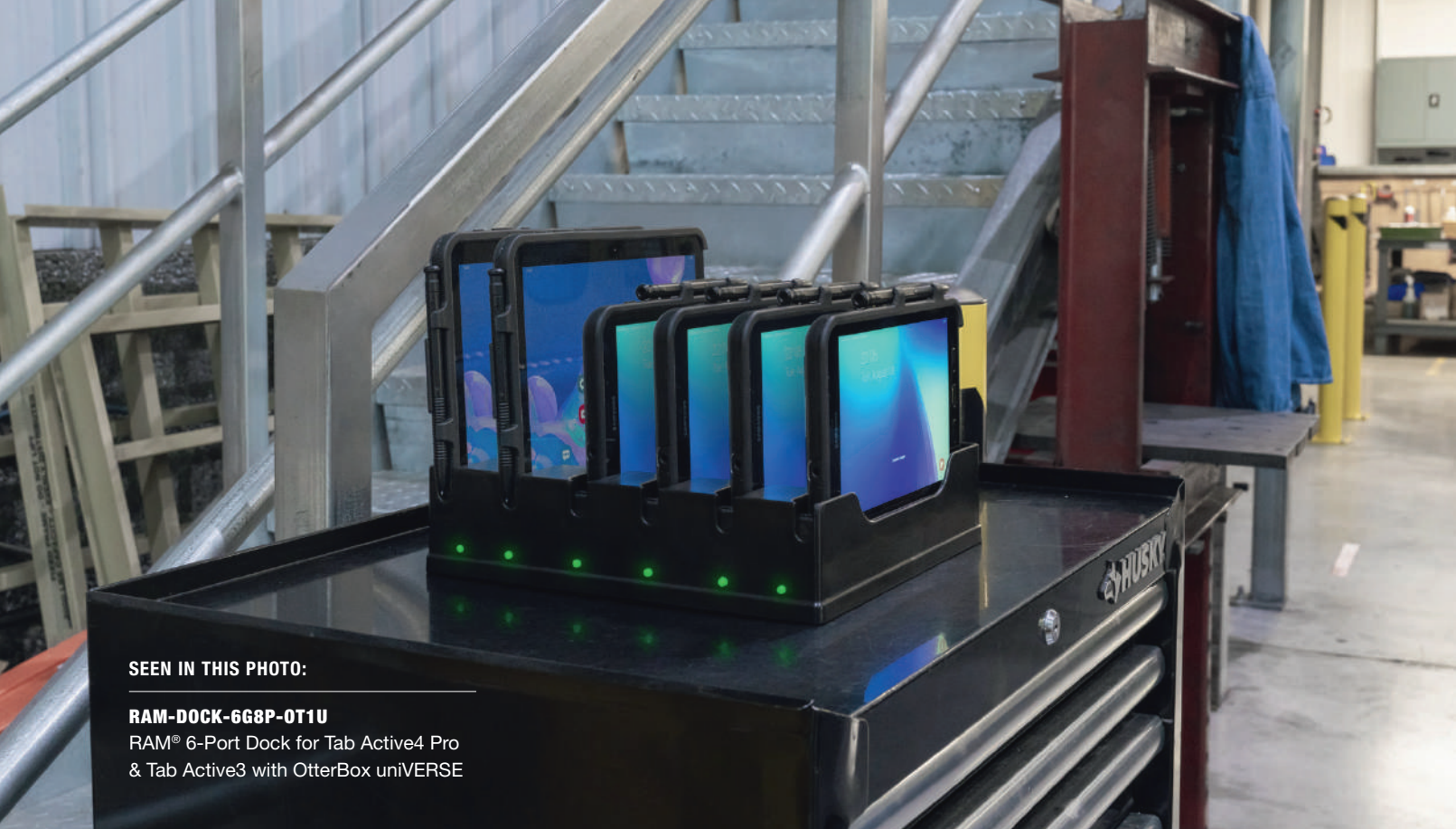

SEEN IN THIS PHOTO:

RAM-DOCK-6G8P-OT1U

RAM® 6-Port Dock for Tab Active4 Pro & Tab Active3 with OtterBox uniVERSE

TABLETS CONTINUED

Desktop Docks for Tablets

The RAM® 6-Port Charging Dock was designed to simultaneously charge up to six Samsung Galaxy tablets, featuring compatibility for the TabActive5, Tab Active4 Pro, Tab Active Pro, Tab Active 3, and Tab Active2. These charging stations reduce desktop clutter by consolidating power through one cord and providing each Samsung tablet with its own contact charging bay, enabled by the device's integrated pogo pads.

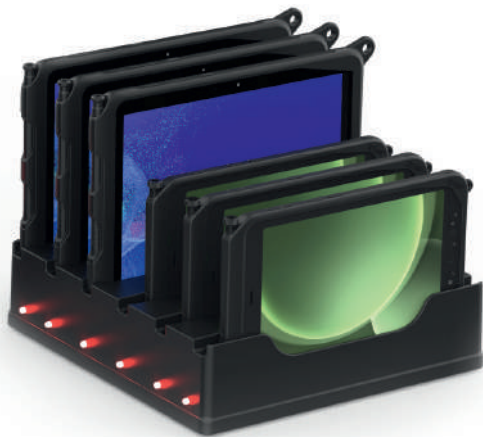

RAM-DOCK-6G8PU

RAM® 6-Port Dock for Samsung Tab Active5 & Tab Active4 Pro



RAM-DOCK-6G8P-OT1U

RAM® 6-Port Dock for Tab Active4 Pro & Tab Active3 with OtterBox uniVERSE

TABLETS CONTINUED

Desktop Docks for Tablets

FEATURES



Charges up to six Tab Active4 Pro, Tab Active Pro, Tab Active3, and Tab Active2 interchangeably



Supports devices with OEM Case, RAM® Skin™, and OtterBox uniVERSE

ADDITIONAL FEATURES

- 1 Integrated pogo-pin contacts align with Samsung Tab Active pogo pads for connectivity
- 2 Removable form-fit spacers used for Tab Active5, 3 & 2
- 3 6-Port dock allows space for ergonomic accessories
- 4 LED lights indicate charge status



IntelliSkin® NG for Tab Active4 Pro



The IntelliSkin® with GDS® Tech™ platform provides protection, charging, and data sync capabilities across a wide range of electronic devices, making it a perfect solution for fleet deployment. With GDS® Compatible™ IntelliSkin® protective sleeves, GDS® Docks™, and GDS® Ecosystem™ accessories, simplify the process of scaling and upgrading devices while taking advantage of a standardized charging and data transfer ecosystem.



Features backwards compatibility for the Tab Active Pro

[CLICK TO SHOP](#)

TAB ACTIVE4 PRO					
PART NUMBER	POWER	KEY LOCKING	SINGLE USB PERIPHERAL	DUAL USB PERIPHERAL	ADDITIONAL INFORMATION
RAM-GDS-DOCK-SAM54CPU	USB-C 2.0				
RAM-GDS-DOCKL-SAM54CPU	USB-C 2.0	•			
RAM-GDS-DOCKLF-SAM54CPU	USB-C 2.0	•			Built-in Fan
RAM-GDS-DOCK-SAM54-MMU	USB-C 2.0		USB-A		Multi-Mode
RAM-GDS-DOCK-SAM54CD2U	USB-C 2.0			(2) USB-A	
RAM-GDS-DOCK-SAM54C-CU	USB-C 2.0		USB-C		
RAM-GDS-DOCK-SAM54CU	USB-C 3.1				
RAM-GDS-DOCKL-SAM54CU	USB-C 3.1	•			
RAM-GDS-DOCKF-SAM54CU	USB-C 3.1				Built-in Fan
RAM-GDS-DOCKLF-SAM54CU	USB-C 3.1	•			Built-in Fan

GDS® Tough-Dock™ for Tab Active4 Pro

The GDS® Tough-Dock™ is a rugged, modular frame for IntelliSkin®-wrapped devices that are highly customizable to your business needs. These docks are key to the GDS® Reach™ experience – standardized charging, data transfer, and simplified scaling.

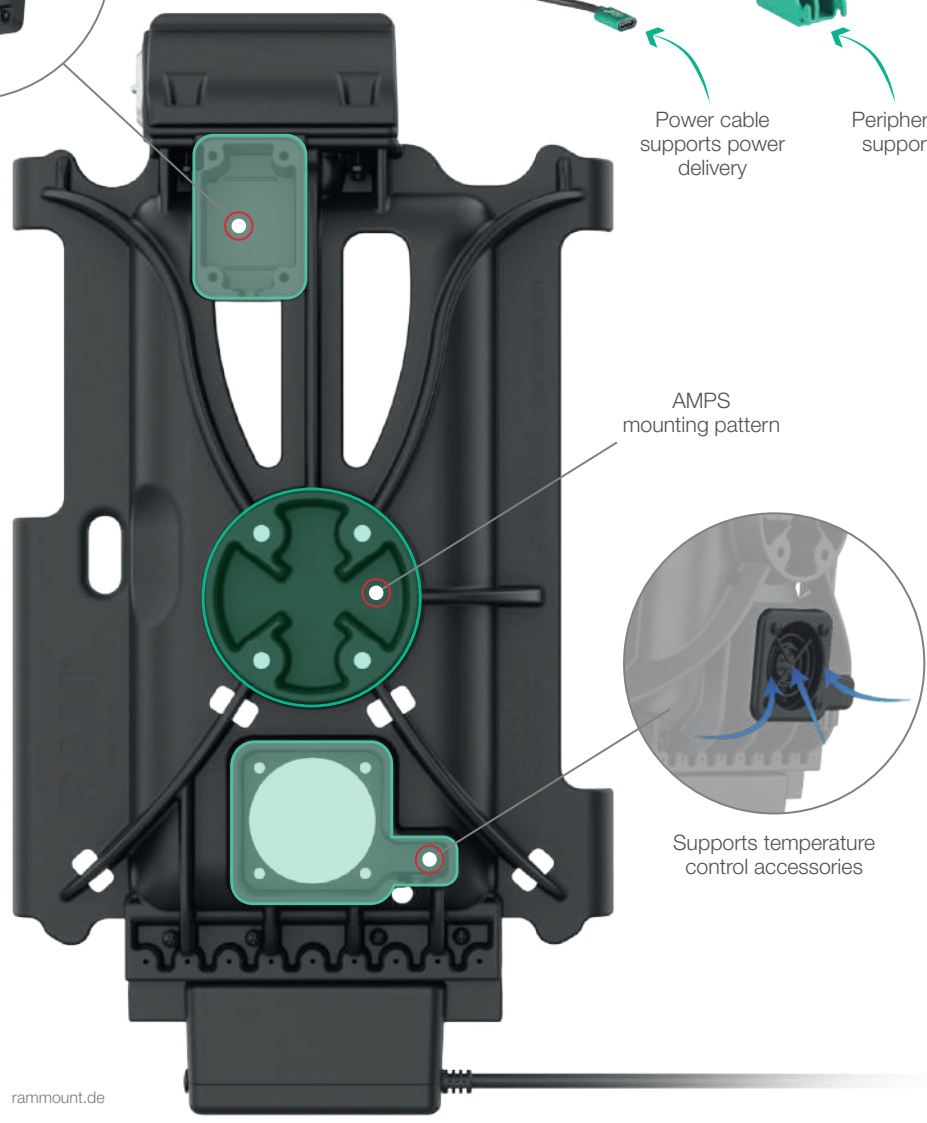

Form-Fit Docks for Tab Active4 Pro

For a slim, clean mounting solution, form-fit holders offer a custom housing that perfectly fits the Samsung Tab Active4 Pro in its original OEM skin or the RAM® Skin™. Numerous features and upgrades include combination locks, key locks, dual USB, and power-only docks.



Available in locking & non-locking



Peripheral data allows connectivity to keyboards, scanners & much more



PUSH-TO-TALK



SCANNERS



KEYBOARD



RAM-HOL-SAM57PKLU

RAM® Key-Locking Powered Dock for Tab Active4 Pro & Tab Active Pro



RAM-HOL-SAM57PDKLU

RAM® Key-Locking Power + Data Dock for Tab Active4 Pro & Tab Active Pro



RAM-HOL-SAM57PD2KLU

RAM® Key-Locking Power + Dual USB Data Dock for Tab Active4 Pro

TABLETS CONTINUED

Form-Fit Docks



SEEN IN THIS PHOTO:

RAM-HOL-SAM57PDKLU

RAM® Key-Locking Power + Data Dock for Tab Active4 Pro & Tab Active Pro

Compatible GDS® Ergo™ Accessories



RAM-GDS-HS1U

GDS® Hand-Stand™ Hand Strap and Kickstand for Tablets



RAM-GDS-HS1MU

GDS® Hand-Stand™ Magnetic Hand Strap and Kickstand for Tablets



RAM-GDS-SS1U

GDS® Shoulder Strap Accessory

TAB ACTIVE4 PRO					
PART NUMBER	POWER	KEY LOCKING	COMBO LOCKING	SINGLE USB PERIPHERAL	DUAL USB PERIPHERAL
RAM-HOL-SAM52PU	mUSB				
RAM-HOL-SAM57PKLU	mUSB	•			
RAM-HOL-SAM57PCLU	mUSB		•		
RAM-HOL-SAM52PDU	mUSB			USB-A	
RAM-HOL-SAM57PDKLU	mUSB	•		USB-A	
RAM-HOL-SAM57PDCLU	mUSB		•	USB-A	
RAM-HOL-SAM52PD2U	mUSB				(2) USB-A
RAM-HOL-SAM57PD2KLU	mUSB	•			(2) USB-A
RAM-HOL-SAM57PD2CLU	mUSB		•		(2) USB-A
RAM-HOL-SAM52CPU	USB-C				
RAM-HOL-SAM57CPKL-CU	USB-C	•		USB-C	
RAM-HOL-SAM57CPKL-CAU	USB-C	•			USB-A & USB-C

IntelliSkin® NG for Tab A Series

The GDS® IntelliSkin® is the cornerstone of the GDS® Reach™ platform that provides protection, charging, and data sync capabilities for a wide range of electronic devices, including the Samsung Tab A series. It's ideal for fleet deployment, as the IntelliSkin® unlocks the GDS® Ecosystem™ including GDS® Docks™ and ergo accessories, allowing businesses to simplify the process of scaling and upgrading devices while taking advantage of this standardized charging and data transfer ecosystem.



NEW RAM-GDS-SKIN-SAM88-NG-LED
IntelliSkin® Next Gen With LED for Samsung Tab A9+



High Strength Composite Shell prevents flex at the connection point

Buttons Fully Accessible

Built-in External LED Light

Hole for Ergonomic Accessories

D-Shaped Platform universal platform ensures seamless fit between GDS® Dock™ and IntelliSkin®

USB Type-C port integrated connector allows for charging even when a GDS® Dock™ is not available

Pogo Pads protects device ports from constant plugging and unplugging, flat for easy cleaning



NEW RAM-GDS-SKIN-SAM88-TC
IntelliSkin® Thin-Case™ for Tab A9+ 11.0"

TABLETS CONTINUED

IntelliSkin® NG for Tab A Series



RAM-GDS-SKIN-SAM80-NG
IntelliSkin® Next Gen for Samsung Tab A7 Lite 8.7



RAM-GDS-SKIN-SAM75-NG
IntelliSkin® Next Gen for Samsung Tab A7 10.4



RAM-GDS-SKIN-SAM83-NG
IntelliSkin® Next Gen for Samsung Tab A8 10.5"

NEW



RAM-GDS-SKIN-SAM88-NG
IntelliSkin® Next Gen for Samsung Tab A9+



RAM-GDS-SKIN-SAM80-NG-LED
IntelliSkin® Next Gen with LED Light for Samsung Tab A7 Lite 8.7



RAM-GDS-SKIN-SAM75-NG-LED
IntelliSkin® Next Gen with LED Light for Samsung Tab A7 10.4



RAM-GDS-SKIN-SAM83-NG-LED
IntelliSkin® Next Gen with LED Light for Samsung Tab A8 10.5"

NEW



RAM-GDS-SKIN-SAM88-NG-LED
IntelliSkin® Next Gen with LED for Samsung Tab A9+



Built-in LED

Select IntelliSkin® cases have a built-in LED option for those limited light situations when you need a flashlight in a pinch.

RAM-GDS-SKIN-SAM80-NG-LED
IntelliSkin® Next Gen with LED Light for Samsung Tab A7 Lite 8.7"



Drop Protection

IntelliSkin® sleeves are MIL-STD-810H drop protection certified, protecting your devices from the shock and impact of harsh environments.

RAM-GDS-SKIN-SAM80-NG
IntelliSkin® Next Gen with LED Light for Samsung Tab A7 Lite 8.7"



Ergo Accessories

The GDS® Hand-Stand™ Hand Strap with Kickstand works with most tablet IntelliSkin® for an easy way to take advantage of workstation enablement.

RAM-GDS-HS1MU
GDS® Hand-Stand™ Magnetic Hand Strap and Kickstand for Tablets

GDS® Tough-Dock™ for Tab A Series

The GDS® Tough-Dock™ is a rugged, modular frame for IntelliSkin®-wrapped Tab A series tablets that are highly customizable to your business needs. These docks are key to the GDS® Reach™ experience – standardized charging, data transfer, and simplified scaling.



Best Sellers



RAM-GDS-DOCKL-SAM80CD2U
Locking GDS® Tough-Dock™ + Dual USB-A for Samsung Tab A7 Lite 8.7"



RAM-GDS-DOCKL-SAM83CDU
Locking GDS® Tough-Dock™ + Single USB-A for Samsung Tab A8 10.5" SM-X200



RAM-GDS-DOCK-SAM88CD2U
GDS® Tough-Dock™ + Dual USB-A for Samsung Tab A9+

Built-in cavity supports ergonomic accessories

Spring-loaded key-locking vehicle dock

Supports temperature control accessories

Power cable supports power delivery

Double USB Type-A for peripheral connection

PUSH-TO-TALK

SCANNERS

KEYBOARD

RAM®
PATENTED & TRADE MARK
FALLING & TRUCK MOUNT
HAMMOUNT SYSTEM

GDS TECHNOLOGY™



TABLETS CONTINUED

GDS® Tough-Dock™



SEEN IN THIS PHOTO:

RAM-GDS-101B2-SAM80CP-V7CU
 GDS® Tough-Dock™ Vehicle Bundle
 for Samsung Tab A7 Lite 8.7"

GDS® Ergo™ Compatible Accessories



RAM-GDS-HS1U

GDS® Hand-Stand™ Hand Strap and Kickstand for Tablets



RAM-GDS-HS1MU

GDS® Hand-Stand™ Magnetic Hand Strap and Kickstand for Tablets



RAM-GDS-ROTO2U

GDS® Roto-Mag™ 3-in-1 Accessory with Grip Handle, Hand Strap & Magnets

TAB A SERIES					
PART NUMBER	POWER	KEY LOCKING	DUAL USB PERIPHERAL	COMPATIBILITY	ADDITIONAL FEATURES
RAM-GDS-DOCK-SAM80-MMU	USB-C			Fits Tab A7 Lite 8.7"	Multi-Mode
RAM-GDS-DOCK-SAM80CDU	USB-C			Fits Tab A7 Lite 8.7"	
RAM-GDS-DOCK-SAM80CPU	USB-C			Fits Tab A7 Lite 8.7"	
RAM-GDS-DOCK-SAM80CD2U	USB-C		USB-A & USB-C	Fits Tab A7 Lite 8.7"	
RAM-GDS-DOCKL-SAM80CDU	USB-C	•		Fits Tab A7 Lite 8.7"	
RAM-GDS-DOCKL-SAM80CPU	USB-C	•		Fits Tab A7 Lite 8.7"	
RAM-GDS-DOCKL-SAM80CD2U	USB-C	•	USB-A & USB-C	Fits Tab A7 Lite 8.7"	
RAM-GDS-DOCK-SAM75CPU	USB-C			Fits Tab A7 10.4"	
RAM-GDS-DOCKL-SAM75CPU	USB-C	•		Fits Tab A7 10.4"	
RAM-GDS-DOCKF-SAM75CPU	USB-C			Fits Tab A7 10.4"	Built-In Fan
RAM-GDS-DOCKLF-SAM75CPU	USB-C	•		Fits Tab A7 10.4"	Built-In Fan
RAM-GDS-DOCK-SAM83CDU	USB-C			Fits Tab A8 10.5"	
RAM-GDS-DOCK-SAM83CPU	USB-C			Fits Tab A8 10.5"	
RAM-GDS-DOCKL-SAM83CDU	USB-C	•		Fits Tab A8 10.5"	
RAM-GDS-DOCKL-SAM83CPU	USB-C	•		Fits Tab A8 10.5"	
RAM-GDS-DOCK-SAM88CPU	USB-C			Fits Tab A9+ 11"	
RAM-GDS-DOCK-SAM88CDU	USB-C		USB-A	Fits Tab A9+ 11"	
RAM-GDS-DOCK-SAM88CD2U	USB-C		Dual USB-A	Fits Tab A9+ 11"	
RAM-GDS-DOCKL-SAM88CPU	USB-C	•		Fits Tab A9+ 11"	
RAM-GDS-DOCKL-SAM88CDU	USB-C	•	USB-A	Fits Tab A9+ 11"	
RAM-GDS-DOCKL-SAM88CD2U	USB-C	•	Dual USB-A	Fits Tab A9+ 11"	

IntelliSkin® NG for Tab S Series

The GDS® IntelliSkin® is the cornerstone of the GDS® Reach™ platform that provides protection, charging, and data sync capabilities for a wide range of electronic devices, including the Samsung Tab S series. It's ideal for fleet deployment, as IntelliSkin® are GDS® Compatible™ and unlock the GDS® Ecosystem™ including GDS® Docks™ and ergo accessories, allowing businesses to simplify the process of scaling and upgrading devices while taking advantage of a standardized charging and data transfer ecosystem.

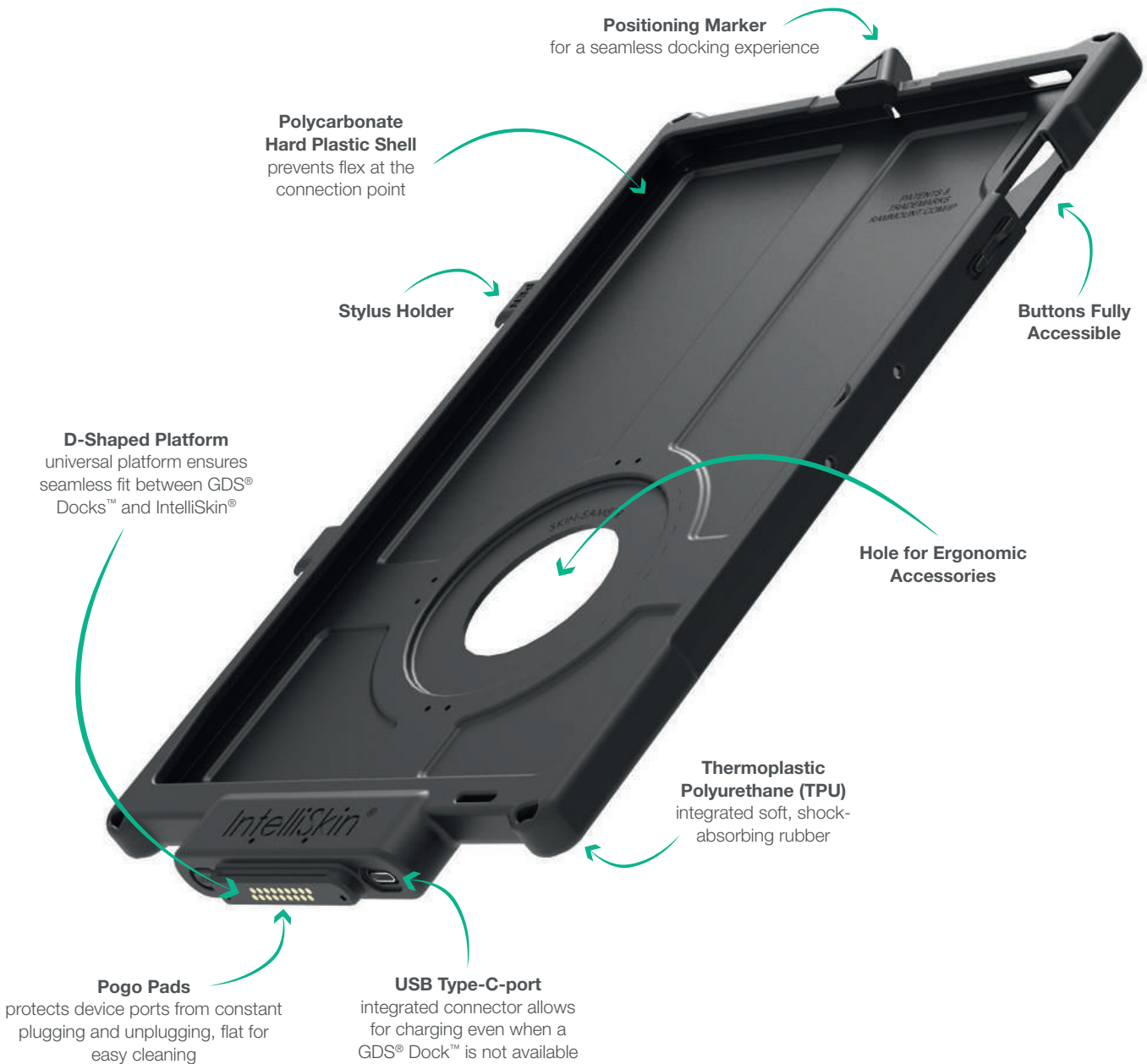

TABLETS CONTINUED

**IntelliSkin® NG
for Tab S
Series**



RAM-GDS-SKIN-SAM76-NG
IntelliSkin® Next Gen for Samsung
Tab S7 11" SM-T870



RAM-GDS-SKIN-SAM78-NG
IntelliSkin® Next Gen for Samsung
Tab S8+, S7+ & S7 FE 12.4"

NEW



RAM-GDS-SKIN-SAM86-NG
IntelliSkin® Next Gen for
Samsung Tab S9 FE

NEW



RAM-GDS-SKIN-SAM87-NG
IntelliSkin® Next Gen for
Samsung Tab S9 FE+



Drop Protection

IntelliSkin® sleeves are MIL-STD-810H drop protection certified, protecting your devices from the shock and impact of harsh environments.

◀ **RAM-GDS-SKIN-SAM76-NG**
IntelliSkin® Next Gen for
Samsung Tab S7 11" SM-T870



Ergo Accessories

The GDS® Hand-Stand™ Hand Strap with Kickstand works with most tablet IntelliSkin® for an easy way to take advantage of workstation enablement.

◀ **RAM-GDS-HS1U**
GDS® Hand-Stand™ Hand Strap
and Kickstand for Tablets

GDS® Tough-Dock™ for Tab S Series

The GDS® Tough-Dock™ is a rugged, modular frame for IntelliSkin®-wrapped Tab S series tablets that are highly customizable to your business needs. These docks are key to the GDS® Ecosystem™ experience – standardized charging, data transfer, and simplified scaling.

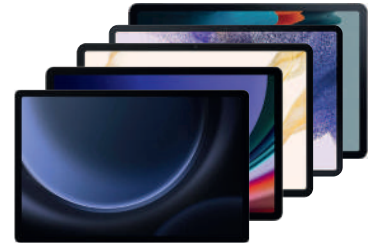

Best Sellers



RAM-GDS-DOCK-SAM76CPU
GDS® Tough-Dock™ for Samsung Tab S7 11" SM-T870



RAM-GDS-DOCKL-SAM78CPU
Locking GDS® Tough-Dock™ for Samsung Tab S8+, S7+ & S7 FE



RAM-GDS-DOCKLF-SAM78CPU
Locking GDS® Cool-Dock™ for Samsung Tab S8+, S7+ & S7 FE

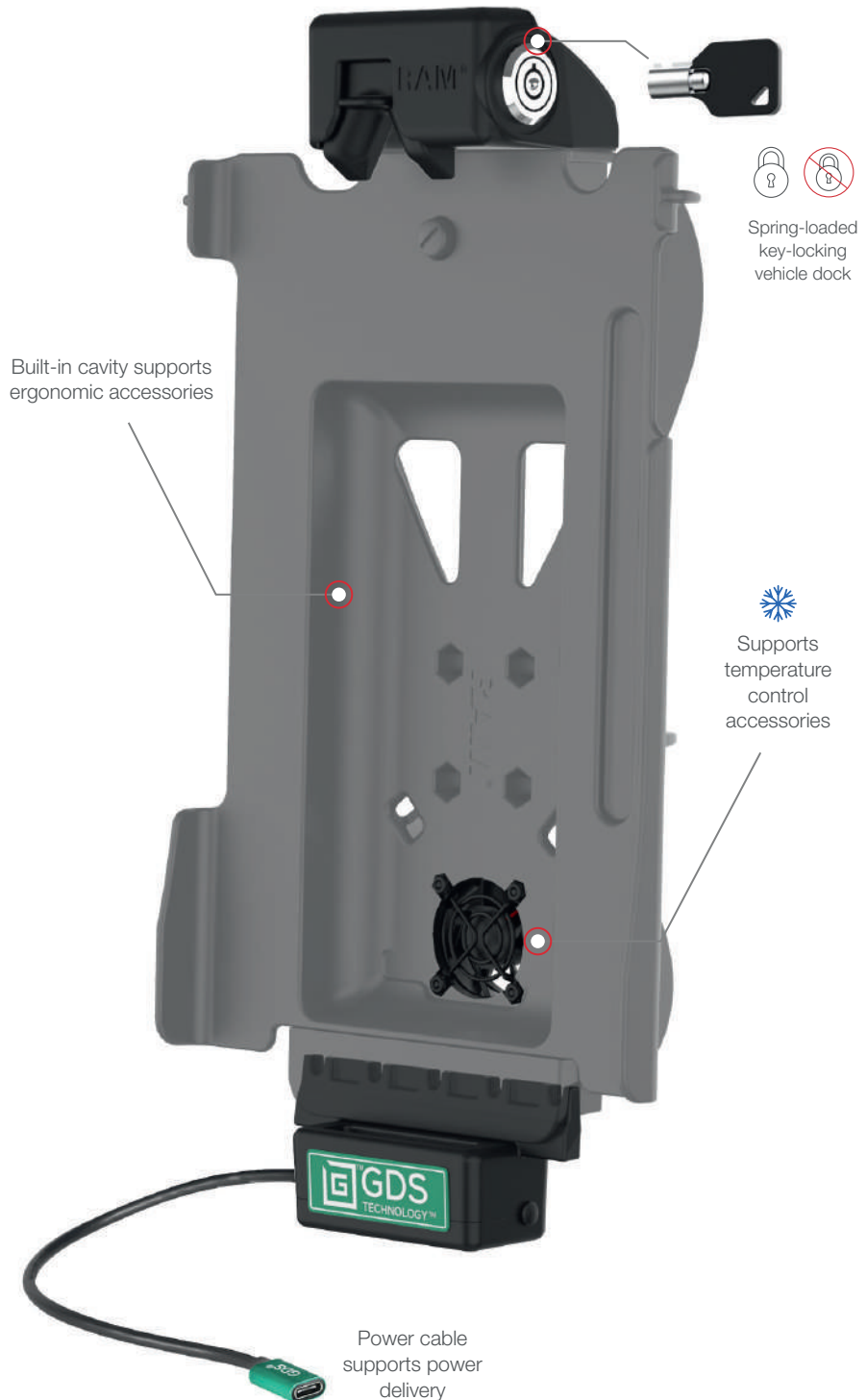



TABLETS CONTINUED

GDS® Tough-Dock™



SEEN IN THIS PHOTO:

RAM-GDS-DOCK-SAM78CPU
GDS® Tough-Dock™ for Samsung Tab S8+, S7+ & S7 FE 12.4"

Compatible GDS® Ergo™ Accessories



RAM-GDS-HS1U

GDS® Hand-Stand™ Hand Strap and Kickstand for Tablets



RAM-GDS-HS1MU

GDS® Hand-Stand™ Magnetic Hand Strap and Kickstand for Tablets



RAM-GDS-ROTO2U

GDS® Roto-Mag™ 3-in-1 Accessory with Grip Handle, Hand Strap & Magnets

TAB S SERIES				
PART NUMBER	POWER	KEY LOCKING	ADDITIONAL INFORMATION	COMPATIBILITY
RAM-GDS-DOCK-SAM76CU	USB-C			Fits Tab S7 and S9 FE
RAM-GDS-DOCK-SAM76CPU	USB-C			Fits Tab S7 and S9 FE
RAM-GDS-DOCKL-SAM76CU	USB-C	•		Fits Tab S7 and S9 FE
RAM-GDS-DOCKL-SAM76CPU	USB-C	•		Fits Tab S7 and S9 FE
RAM-GDS-DOCK-SAM78CU	USB-C			Fits Tab S7+, S7 FE, S8+ and S9 FE+
RAM-GDS-DOCK-SAM78CPU	USB-C			Fits Tab S7+, S7 FE, S8+ and S9 FE+
RAM-GDS-DOCKL-SAM78CU	USB-C	•		Fits Tab S7+, S7 FE, S8+ and S9 FE+
RAM-GDS-DOCKL-SAM78CPU	USB-C	•		Fits Tab S7+, S7 FE, S8+ and S9 FE+
RAM-GDS-DOCKF-SAM78CPU	USB-C		Built-In Fan	Fits Tab S7+, S7 FE, S8+ and S9 FE+
RAM-GDS-DOCKLF-SAM78CPU	USB-C	•	Built-In Fan	Fits Tab S7+, S7 FE, S8+ and S9 FE+

Phones

Samsung XCover6 Pro & XCover5

RAM® Mounts offers a variety of solutions for Samsung's newest rugged smartphone. Whether you're on the go or in the office, powered accessories are essential for keeping your XCover6 Pro and XCover5 charged and connected. Protect your investment and improve your workflow with enterprise-ready solutions utilizing IntelliSkin®, and GDS® Technology™.



RAM-GDS-SKIN-SAM84

IntelliSkin® for Samsung Galaxy XCover6 Pro



RAM-SKIN-SAM84

RAM® Skin™ for Samsung Galaxy XCover6 Pro



RAM-HOL-SAM84PU

RAM® EZ-Roll'r™ Powered Dock for Samsung XCover6 Pro Without Case



RAM-HOL-SAM84CP-1U

RAM® EZ-Roll'r™ Powered Dock for XCover6 Pro with OEM or RAM® Skin™



RAM-HOL-SAM10PU

RAM® Powered Dock for Samsung XCover5



RAM-SKIN-SAM79

RAM® Skin™ for Samsung Galaxy XCover5

GDS® Hand Straps

NEW



RAM-GDS-HS4U

GDS® Hand Strap for Phones with IntelliSkin® or RAM® Skin™

NEW



RAM-GDS-HS4MU

GDS® Magnetic Hand Strap for Phones with IntelliSkin® or RAM® Skin™



SEEN IN THIS PHOTO:

RAM-GDS-HS4U

GDS® Hand Strap for Phones with IntelliSkin® or RAM® Skin™

PHONES CONTINUED

Compatible GDS® Docks™ for Samsung XCover6 Pro & XCover5

NEW



RAM-GDS-DOCK-V3CPAU
GDS® Vehicle Dock with USB-C 2.0 for XCover6 Pro with IntelliSkin®

Not compatible with GDS® Hand Strap accessory. For an alternate dock that supports hand strap, see **RAM-GDS-DOCK-V11CU**



RAM-GDS-DOCK-D7U
GDS® Desktop Dock with Power Delivery



RAM-GDS-DOCK-6G15P-RJ45
GDS® 6-Port Power + RJ45 Dock for Handhelds with IntelliSkin®

FEATURES

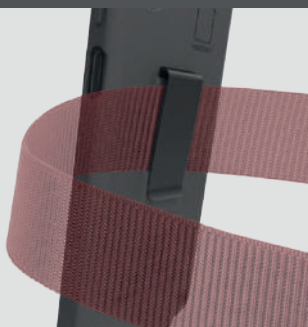

Includes built-in belt clip adapter



Military-grade drop protection to withstand shock and impact



RAM® EZ-Roll'r™ powered dock perfectly secures the Samsung Galaxy XCover6 Pro



When connected to a power source, integrated pogo pins provide charging capabilities to the device



RAM® EZ-Roll'r™ powered dock leaves the device's buttons and cameras exposed and accessible

2-Hole AMPS



Mount your dock anywhere with any B or C size components that are compatible with the 2-hole AMPS hole pattern located on the back

SEEN IN THIS PHOTO:

RAM-HOL-SAM59U

RAM® EZ-Roll'r™ Cradle

RAM-B-238U

RAM® Diamond Ball Base

RAM-B-201U-C

RAM® Double Socket Arm

RAP-B-400U

RAM® Tough-Claw™ Small
Clamp Base with Ball



SEEN IN THIS PHOTO:

RAM-B-166-SAM9PU

RAM® EZ-Roll'r™ Powered
Suction Cup Mount for
Samsung XCover Pro



FEATURES

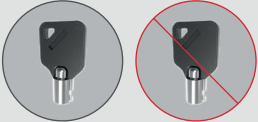

Locking & non-locking options available

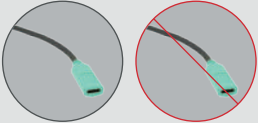

Powered & non-powered options available

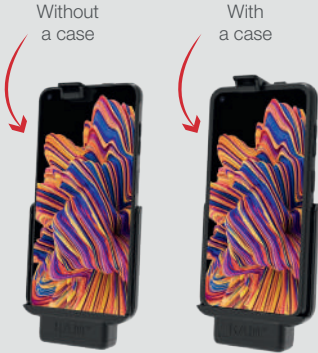

Without a case With a case

Solutions for XCover Pro with case, without a case, and with an OtterBox uniVERSE case

PHONES CONTINUED

Samsung XCover Pro & FieldPro

Both the Samsung XCover Pro & FieldPro take some of the best features of current Tab Active tablets by introducing the pogo-pad technology for charging purposes. RAM® supports these kinds of innovations with pogo-pin enabled powered docks. Of course, with a non-powered option available, the RAM® EZ-Roll'r™ system supports the Samsung XCover Pro without a case as well as an option for OtterBox uniVERSE-wrapped XCover Pros. Simply drop the device into the powered cradle and the aligned pogo-pins to pogo-pads instantly enable charging.



RAM-GDS-DOCKL-V3CU
GDS® Locking Vehicle Phone Dock + Data with USB Type-C for IntelliSkin®



RAM-GDS-SKIN-SAM59
IntelliSkin® for Samsung Galaxy XCover Pro



RAM-HOL-SAM59U
RAM® EZ-Roll'r™ Cradle for Samsung XCover Pro



RAM-HOL-SAM9P-OT2U
RAM® Powered Dock for Samsung XCover Pro with OtterBox uniVERSE



RAM-HOL-SAM9PU
RAM® EZ-Roll'r™ Powered Dock for Samsung XCover Pro



RAM-HOL-SAM72PU
RAM® Powered Dock for Samsung XCover FieldPro



SEEN IN THIS PHOTO:

RAM-DOCK-6G-SAM59P-OT1U

RAM® 6-Port Charging Dock for Samsung XCover Pro with OtterBox uniVERSE

PHONES CONTINUED

Multi-Port Chargers for XCover Series

Custom designed for each Samsung XCover phone model, each RAM® 6-Port Charging Dock supports up to six phones for simultaneous charging. These charging stations reduce the amount of charging cords needed to charge each device by consolidating power through one cord and provide each Samsung phone with its own charging bay.

FEATURES

Plugs directly into standard wall outlets

Integrated pogo pin contacts provide charging power to the device and protects the device's ports from constant plugging and unplugging

PHONES CONTINUED

Multi-Port Chargers for XCover Series



RAM-DOCK-6G-SAM59PU

RAM® 6-Port Charging Dock for Samsung XCover Pro



RAM-DOCK-6G-SAM84PU

RAM® 6-Port Charging Dock for Samsung XCover6 Pro without Case



RAM-DOCK-6G-SAM84CPU

RAM® 6-Port Charging Dock for Samsung XCover6 Pro with RAM® Skin™



RAM-DOCK-6G-SAM10PU

RAM® 6-Port Charging Dock for Samsung XCover 5



RAM-DOCK-6G-SAM72PU

RAM® 6-Port Charging Dock for Samsung XCover FieldPro



RAM-DOCK-6G-SAM59P-OT1U

RAM® 6-Port Charging Dock for Samsung XCover Pro with OtterBox uniVERSE

Galaxy Phones

Deploy a fleet of Samsung Galaxy phones with GDS® Technology™ to streamline your team's workflow and enjoy the scalable GDS® Ecosystem™ that keeps devices charged, protected, and connected. When it's time to upgrade, easily swap out your device and IntelliSkin® and retain your existing docks and mounting solution.



Adjustable top cup accommodates any size phone wrapped in an IntelliSkin®



Military-grade drop protection to withstand shock and impact



GDS® connector and docking contacts provide charging and data sync capabilities



Available in locking & non-locking

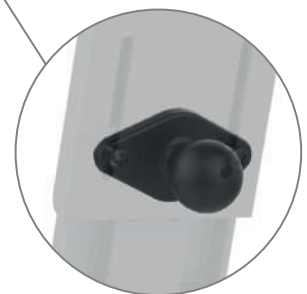

Compatible with B and C size RAM® diamond bases for attaching a double socket arm



RAM-GDS-DOCKL-V3CPU

GDS® Locking Vehicle Phone Dock with USB Type-C 2.0 for IntelliSkin®

PHONES CONTINUED

Desktop & Vehicle Docking Options for Galaxy Phones



SEEN IN THIS PHOTO:

- RAM-GDS-DOCK-V3CPU**
GDS® Locking Vehicle Phone Dock with USB Type-C 2.0 for IntelliSkin®
- RAM-GDS-SKIN-SAM71**
IntelliSkin® for Samsung Galaxy S20 Ultra 5G
- RAM-B-103-238U**
RAM® Double Socket Arm with Diamond Plate
- RAM-B-202U**
RAM® Round Plate with Ball - B Size

RAM-GDS-DOCK-V3CPAU
GDS® Vehicle Dock with USB-C 2.0 for XCover6 Pro with IntelliSkin®

RAM-GDS-DOCK-D7U
GDS® Desktop Dock with Power Delivery

Compatible IntelliSkin®



RAM-GDS-SKIN-SAM61
fits A20



RAM-GDS-SKIN-SAM69
fits S20 5G



RAM-GDS-SKIN-SAM70
S20+ 5G



RAM-GDS-SKIN-SAM71
S20 Ultra 5G



RAM-GDS-SKIN-SAM77
fits S20 FE 5G

Universal Docks

GDS® Multi-Port Docks

The RAM® 6-Port Charging Dock was designed to simultaneously charge up to six devices. These charging stations reduce desktop clutter by consolidating power through one cord and providing each Samsung device with its own contact charging bay, enabled by the device's integrated pogo pads.



RAM-GDS-DOCK-6G15P
GDS® 6-Port Powered Dock
for Handhelds with IntelliSkin®



Additional Features

- 1 Charges up to six IntelliSkin®-wrapped handheld devices simultaneously
- 2 Plugs directly into standard wall outlets
- 3 Six ethernet ports allow for secure software updates during downtime
- 4 Weighted base and rubber feet for stability
- 5 Integrated pogo-pins and distinctive D shape for all IntelliSkin® Next Gen (NG) and legacy

RAM-GDS-DOCK-6G15P-RJ45
GDS® 6-Port Power + RJ45 Dock for Handhelds with IntelliSkin®

UNIVERSAL DOCKS CONTINUED

GDS® Multi-Port Docks

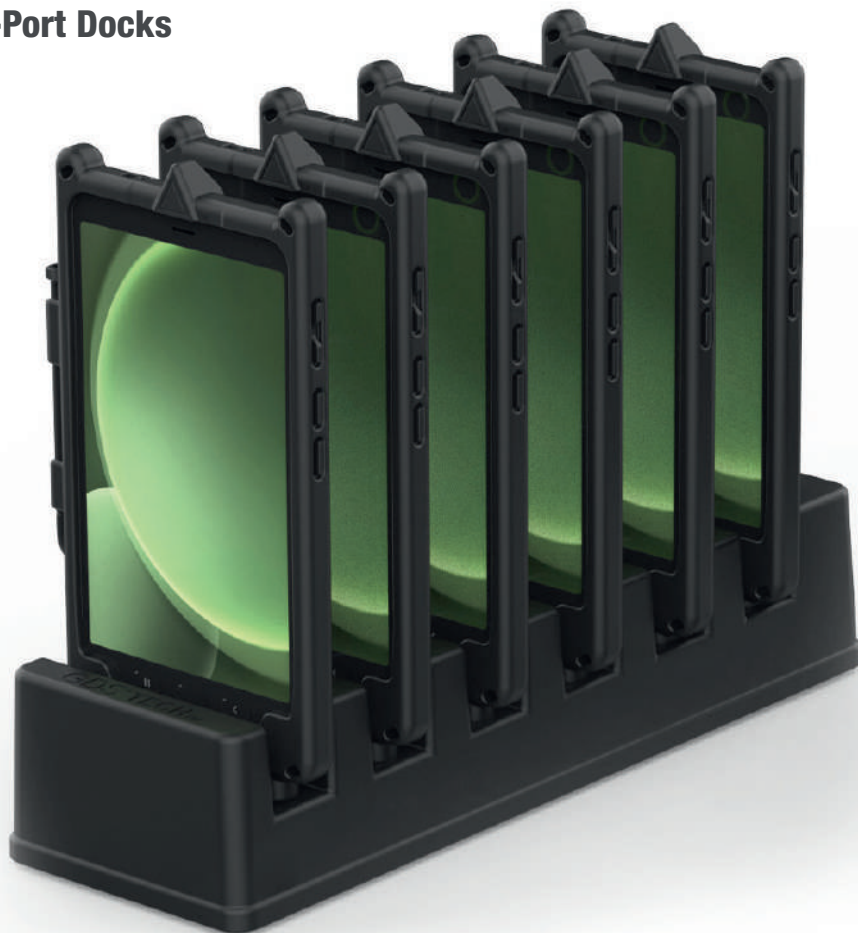

RAM-GDS-DOCK-6G16P-RJ45

GDS® 6-Port Power + RJ45 Dock for Tablets with IntelliSkin®

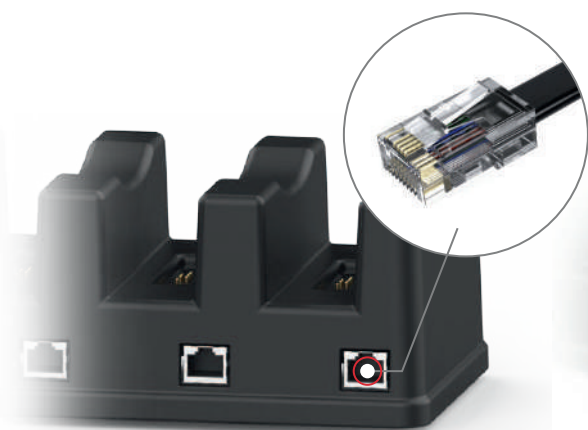

RJ45 Availability

Available versions of this desktop dock include up to six built-in RJ45 ports for pushing data over secure ethernet connection.



Built-in Cooling Fan

Each RJ45 dock includes built-in cooling fan designed to push air out of the dock to prevent overheating during data transfer.

UNIVERSAL DOCKS CONTINUED

Additional Features

- 1 Supports devices that require power delivery
- 2 Steel weighted base with rubber pads creates strong hold on desktop
- 3 Integrated pogo-pins and distinctive D shape for all IntelliSkin® Next Gen (NG) and legacy
- 4 6-Port Dock allows space for ergonomic accessories



RAM-GDS-DOCK-6G1PD-NGU

GDS® 6-Port Power Delivery Desktop Charger for IntelliSkin® Next Gen

GDS® 6-PORT CHARGING DOCKS

PART ID	DEVICE TYPE	POWER DELIVERY	ETHERNET
RAM-GDS-DOCK-6G1PD-NGU	Phone & Tablet	•	Not supported
RAM-GDS-DOCK-6G1P-NGU	Phone & Tablet	Not supported	Not supported
RAM-GDS-DOCK-6G15P	Phone	•	Not supported
RAM-GDS-DOCK-6G15P-RJ45	Phone	•	6 Ports (One Per Device)
RAM-GDS-DOCK-6G9PU	Phone	Not supported	Not supported
RAM-GDS-DOCK-6G16P	Tablet	•	Not supported
RAM-GDS-DOCK-6G16P-RJ45	Tablet	•	6 Ports (One Per Device)
RAM-GDS-DOCK-6G16P-SW1	Tablet	•	1 Port (Connects All Devices)

Multi-Port for Handhelds

The GDS® 6-Port Desktop Charger was designed to support up to six phones for simultaneous charging.



◀ **RAM-GDS-DOCK-6G9PU**
GDS® 6-Port Desktop Charger for Phones with IntelliSkin®

GDS® Desktop Docks

Perfect for office environments, GDS® desktop docks can support any device equipped with an IntelliSkin® sleeve to deliver full-time charging as well as data transfer capabilities. These docks keep electronic devices protected and at the ready. GDS® desktop docks support a number of electronic devices as well as power and data communication.



GDS® Tech™ and pogo pin technology is scalable as devices evolve, minimizing overhead for future upgrades with its universal design.



RAM-GDS-DOCK-D7U
GDS® Desktop Dock with Power Delivery



RAM-GDS-DOCK-D7AU
GDS® Desktop Dock with Power Delivery & Peripheral Port

GDS® DESKTOP DOCKS					
PART ID	CASE IntelliSkin® Next Gen	CASE Phone & Legacy IntelliSkin®	POWER	PERIPHERAL	COMPATIBILITY Samsung DeX
RAM-GDS-DOCK-D7U	•	•	USB-C		
RAM-GDS-DOCK-D7AU	•	•	USB-C	USB-A	
RAM-GDS-DOCK-D2CM-NDU	•		USB-C		•
RAM-GDS-DOCK-D2C-NDU	•		USB-C		•
RAM-GDS-DOCK-D2CMU		•	USB-C		
RAM-GDS-DOCK-D2U		•	mUSB		

FEATURES



Low-profile docking station for electronic devices equipped with an IntelliSkin® protective case

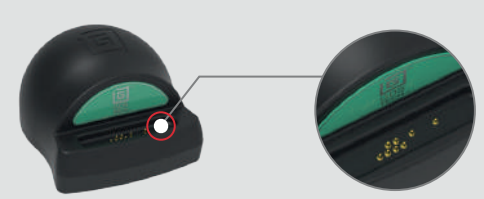

The Desktop Dock features pogo pin contacts designed to match the pogo pads on IntelliSkin®-wrapped devices supporting USB Type-C data transfer and charging profiles



Power Delivery docks include a male to male USB Type-C cord which plugs directly into the back of the dock and to a Power Delivery charging source, or external hub

SEEN IN THIS PHOTO

RAM-GDS-DOCK-G7M-8-NGU
GDS® Slide-Dock™ with Power
Delivery & Magnetic Base



UNIVERSAL DOCKS CONTINUED

GDS® Slide-Dock™

Designed to enable efficient and effective fleet charging, the GDS® Slide-Dock™ is a scalable solution for charging multiple devices. It features a simple installation process that only requires a flat surface—making it the ideal solution for charging carts, cabinets, or any other secure location your devices go while not in use. Each GDS® Slide-Dock™ includes an LED indicator light that lets you know whether or not the dock is connected to power and is available with a drill-down or magnetic base.



RAM-GDS-DOCK-G7M-8-NGU
GDS® Slide Dock™ with with Power Delivery & Magnetic Base

UNIVERSAL DOCKS CONTINUED

GDS® Slide-Dock™ Chargers

Built-in Type-C ports for charging



Fan clears heat from the dock to prevent overheating



RAM-GDS-CHARGE-USBC-12 >
GDS® 12-Port 300W USB-C Power Delivery Wall Charger

RAM-GDS-CHARGE-USBC-RJ45-12 >
GDS® 12-Port 300W USB-C + RJ45 Power Delivery Wall Charger

Built-in RJ45 ports for pushing data over ethernet

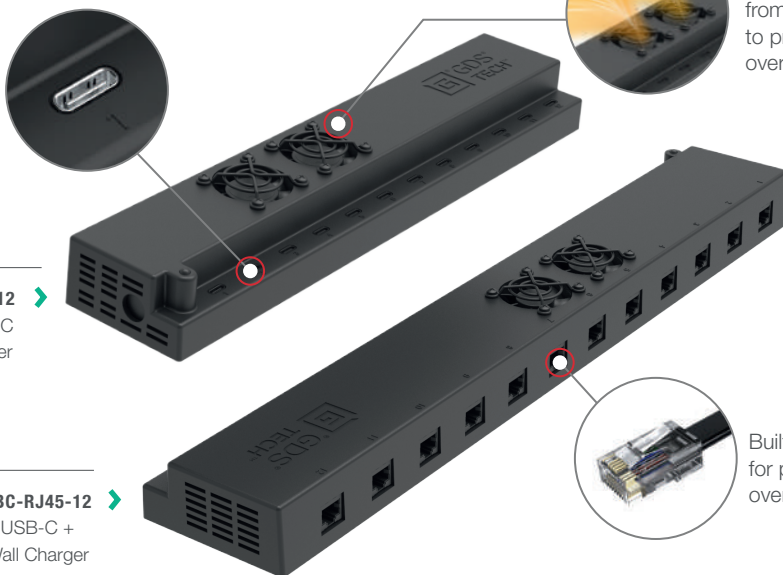

GDS® SLIDE DOCKS™

PART NUMBER	MOUNT TYPE	POWER CONNECTOR
RAM-GDS-DOCK-G7B-8-NGU	Drill-Down	USB-C Male
RAM-GDS-DOCK-G7M-8-NGU	Magnetic	USB-C Male
RAM-GDS-DOCK-G7-8-NGU	Module Only	USB-C Male
RAM-GDS-DOCK-G7B-NGU	Drill-Down	USB-A Male
RAM-GDS-DOCK-G7M-NGU	Magnetic	USB-A Male
RAM-GDS-DOCK-G7-NGU	Module Only	USB-A Male

FEATURES

The GDS® Slide-Dock™ has a USB Type-C male output that can plug into an existing USB port on a cart

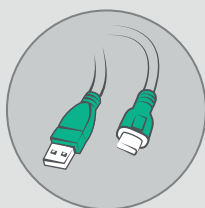

There is an LED indicator light that turns red when your dock is connected to power



Adjustable height accommodates a variety of different devices

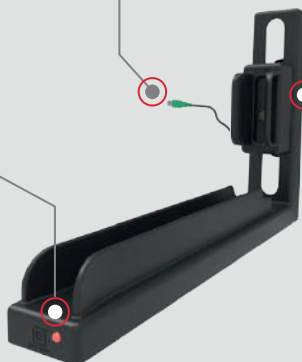

Universal Holders

RAM® X-Grip®, Tab-Tite™ and Tab-Lock™ for Samsung Tablets

For a cost-effective mounting solution, consider the universal tablet holders available from RAM® Mounts. With two distinct styles, these rugged device holders offer unique features. The RAM® X-Grip® boasts a wide range of compatibility for a future-proofed solution while the RAM® Tab-Tite™ and Tab-Lock™ offer a more custom fit via swappable cups and optional locking for extra theft deterrence.

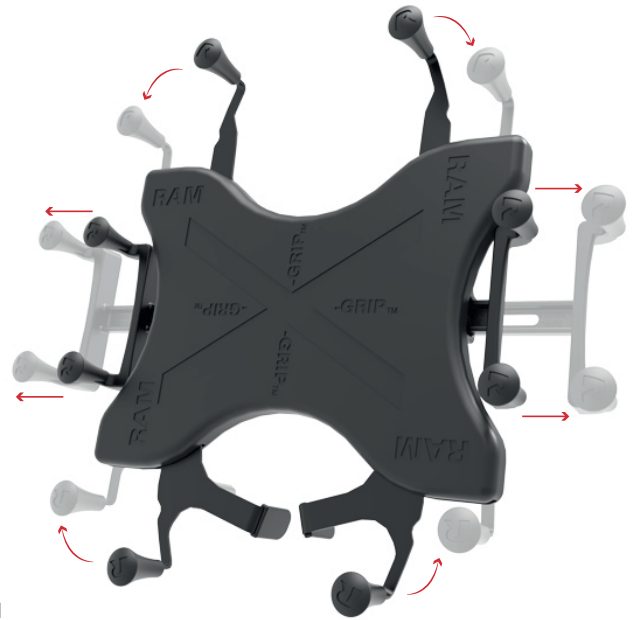

RAM® X-GRIP®

Additional grip handles for convenient insertion and removal

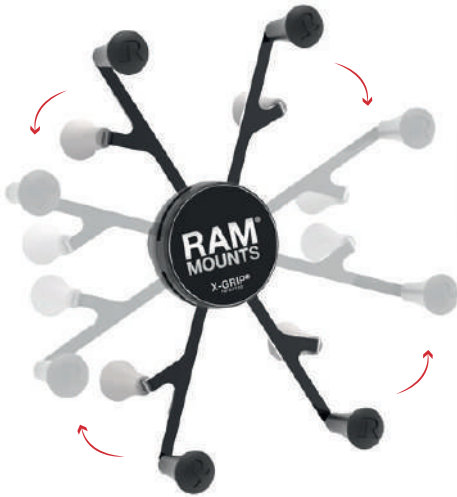

Steel spring-loaded arms keep tablets secure



Highly adjustable to support tablets in portrait and landscape mode

RAM® X-GRIP®			
TAB S SERIES		TAB A SERIES	
MODEL	COMPATIBILITY	MODEL	COMPATIBILITY
RAM-HOL-UN9U	Fits Tab S7, S7+, S7 FE, S8+, S9, S9+, S9 FE, S9 FE+	RAM-HOL-UN8BU	Fits A7 Lite 8.7" & Tab A9 with or without Case
RAM-HOL-UN11U	Fits Tab S8 Ultra	RAM-HOL-UN9U	Fits Tab A7 10.4", Tab A8 10.5" & Tab A9+ with or without Case



UNIVERSAL HOLDERS CONTINUED

Universal Solutions for Samsung Tablets

RAM® TAB-TITE™



RAM-HOL-TAB33U

RAM® Tab-Tite™ Holder for 10.1" - 10.5" Tablets with or without Case

RAM® TAB-LOCK™



RAM-HOL-TABL28U

RAM® Tab-Lock™ Spring Loaded Holder for 9.7" Tablets



TAB-TITE™ & TAB-LOCK™

TAB S SERIES

MODEL

COMPATIBILITY

RAM-HOL-TAB20U	Fits Tab S7, S8, S9, S9 FE
RAM-HOL-TABL20U	Fits Tab S7, S8, S9, S9 FE
RAM-HOL-TAB28U	Fits Tab S7, S8, S9, S9 FE
RAM-HOL-TABL28U	Fits Tab S7, S8, S9, S9 FE
RAM-HOL-TAB36U	Fits Tab S7, S7+, S7 FE, S8+, S9+, S9 FE+
RAM-HOL-TABL36U	Fits Tab S7, S7+, S7 FE, S8+, S9+, S9 FE+

TAB A SERIES

MODEL

COMPATIBILITY



RAM-HOL-TAB12U	Fits Tab A7 Lite 8.7" & Tab A9 with case
RAM-HOL-TABL12U	Fits Tab A7 Lite 8.7" & Tab A9 with case
RAM-HOL-TAB24U	Fits Tab A7 Lite 8.7" & Tab A9
RAM-HOL-TABL24U	Fits Tab A7 Lite 8.7" & Tab A9
RAM-HOL-TAB25U	Fits Tab A9+
RAM-HOL-TABL25U	Fits Tab A9+
RAM-HOL-TAB28U	Fits Tab A8 10.5" & Tab A9+
RAM-HOL-TABL28U	Fits Tab A8 10.5" & Tab A9+
RAM-HOL-TAB33U	Fits Tab A7 10.4" & Tab A8 10.5" with Case
RAM-HOL-TABL33U	Fits Tab A7 10.4" & Tab A8 10.5" with Case

UNIVERSAL HOLDERS CONTINUED

RAM® X-Grip®, Quick-Grip™ and Tough-Charge™ for Samsung Phones

RAM® Mounts universal device holders are the most rugged, durable device holders on the market. With a spring-loaded design, both the RAM® X-Grip® and RAM® Quick-Grip™ expand and contract for a perfect fit to whatever phone model you're using. If you're looking to maintain your device's charge, consider the powered versions—RAM® Tough-Charge™ and RAM® Quick-Charge™.



 Water Proof
 Fast Charge

RAM-HOL-UN14WB-1
RAM® Quick-Grip™ 15W Waterproof Wireless Charging Holder with Ball





RAM-HOL-UN7BU
RAM® X-Grip® Universal Phone Holder with Ball - B Size



RAM-HOL-UN10BU
RAM® X-Grip® Large Phone Holder with Ball - B Size



 Water Proof
 Fast Charge

RAM-HOL-UN12WB-1
RAM® Tough-Charge™ with X-Grip® 15W Waterproof Wireless Charging Holder



RAM-HOL-PD4-238AU
RAM® Quick-Grip™ XL Phone Holder with Ball

NEW



RAM-HOL-PD4-462B
RAM® Quick-Grip™ XL Phone Holder with Vibe-Safe™ Adapter & Ball

FEATURES



Waterproof Qi compatible wireless phone charging cradle features spring-loaded RAM® X-Grip® technology and 15W maximum output

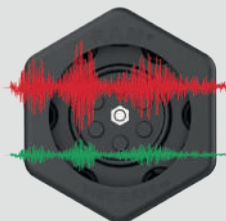

The RAM® Vibe-Safe™ (sold separately) is a new compatible accessory for universal phone holders that dampens a wide range of vibration frequencies

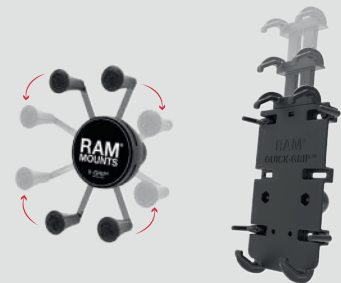

Universal Holders provide a perfect fit for your phone with or without a case

UNIVERSAL HOLDERS CONTINUED

Universal Solutions for Samsung Phones



SEEN IN THIS PHOTO:

RAM-HOL-UN10BU

RAM® X-Grip® Large Phone
Holder with Ball - B Size



Future-Proofing Modular Components

The modularity of GDS® Docks™ provide the highest quality and most cost-effective solutions for tablets, including inevitable future device upgrades. With interchangeable dock latch and bases, it's easy to modify existing mounting systems without breaking the bank on an entirely new system.

TOP CUPS



RAM-GDS-DOCKH2U
GDS® Tough-Dock™
& Cool-Dock™ Top Latch



RAM-GDS-DOCKLH2U
GDS® Tough-Dock™ & Cool-Dock™
Locking Top Latch

RAM-GDS-DOCK-V10C-CU
GDS® Power + USB-C Data
Dock Cup for IntelliSkin®
Next Gen Tablets



BOTTOM CUPS	POWER CONNECTOR	PERIPHERAL PORTS
RAM-GDS-DOCK-V10PU	USB-C 2.0	—
RAM-GDS-DOCK-V10PDU	USB-C 2.0	USB-A
RAM-GDS-DOCK-V10PD2U	USB-C 2.0	Dual USB-A
RAM-GDS-DOCK-V10C-CU	USB-C 2.0	USB-C
RAM-GDS-DOCK-V10C-CAU	USB-C 2.0	USB-C USB-A
RAM-GDS-DOCK-V10C-RJ45AU	USB-C 2.0	RJ45 USB-A

Input Devices

GDS® Tech™ bases support peripheral enablement and allow users to connect up to two peripherals directly to their device. With a variety of accessories available in the GDS® Ecosystem™, you can easily swap as the needs of your company grow.

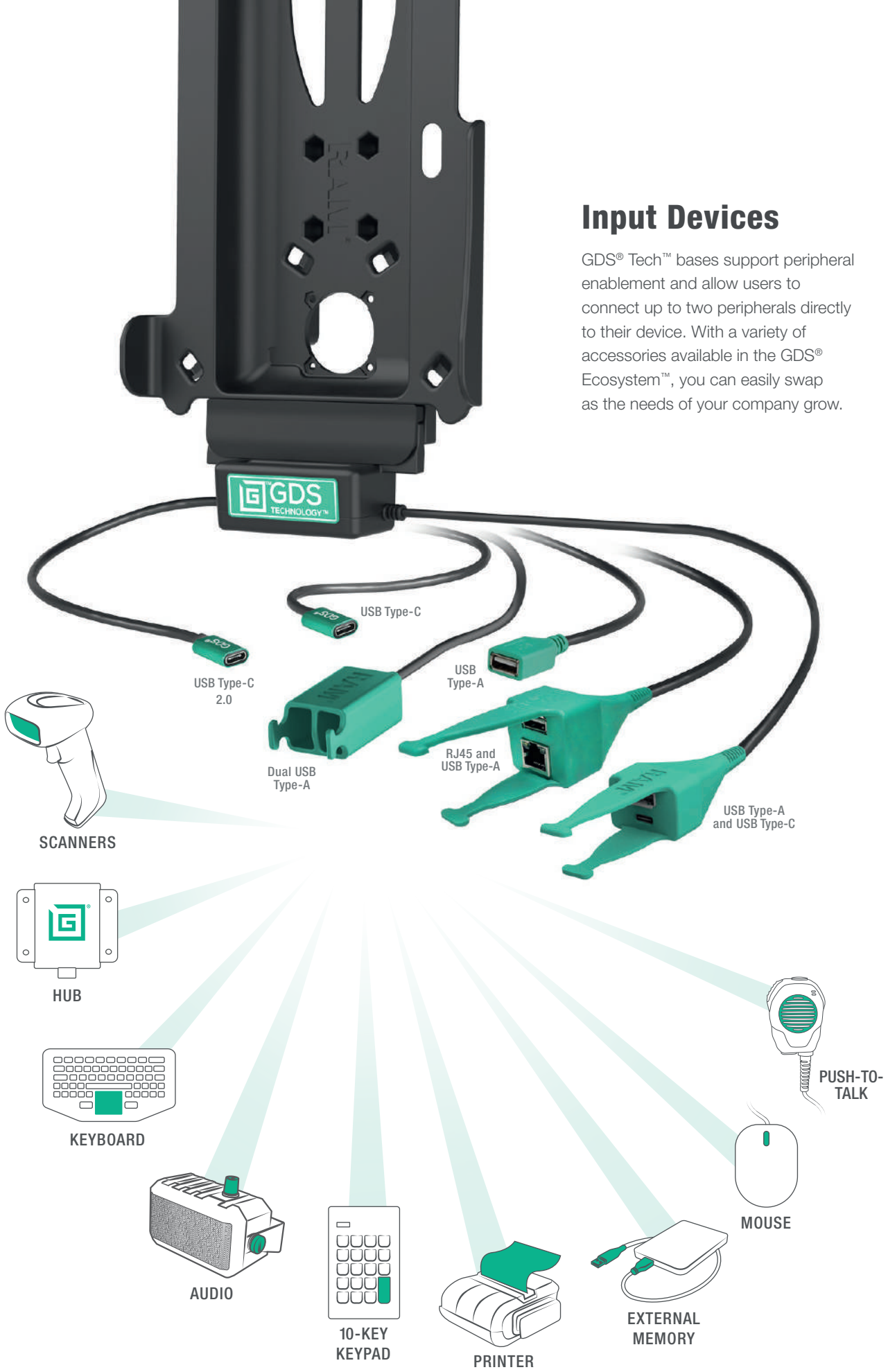

ACCESSORIES

RAM® Skin™ & IntelliSkin® Accessories



SEEN IN THESE PHOTOS:

RAM-GDS-ROTO2U

GDS® Roto-Mag™ 3-in-1 Accessory with Grip Handle, Hand Strap & Magnets



Accessories

RAM® Skin™ & IntelliSkin® NG Accessories

The RAM® Skin™ and IntelliSkin® product lines are compatible with a variety of GDS® Ergo™ accessories that enable your tablet for field use. Make traveling with your tablet more comfortable and efficient by pairing your device with the GDS® Hand-Stand™—this combination hand strap and kickstand accessory allows you to take your device from the warehouse to the office and everywhere in between. Take advantage of mounting your tablet to magnetic surfaces with the GDS® Roto-Mag™ and the magnetic version of the GDS® Hand-Stand™.



RAM-GDS-HS1U
GDS® Hand-Stand™ Hand Strap and Kickstand for Tablets



RAM-GDS-ROTO2U
GDS® Roto-Mag™ 3-in-1 Accessory with Grip Handle, Hand Strap & Magnets



RAM-GDS-HS1MU
GDS® Hand-Stand™ Magnetic Hand Strap and Kickstand for Tablets



While the GDS® Roto-Mag™ fits both RAM® Skin™ and IntelliSkin®, it will not fit in the non-GDS® Form-Fit docks



RAM-GDS-SS1U
GDS® Shoulder Strap Accessory

FEATURES



Use the GDS® Hand-Stand™ as a hand strap or as a kickstand when the tablet is stationary



Rotate between portrait and landscape mode with the GDS® Roto-Mag™



Connect the GDS® Shoulder Strap to your RAM® Skin™ or IntelliSkin®-wrapped device with the corner attachment points

ACCESSORIES

Temperature Control Products

SEEN IN THESE PHOTOS:

RAM-GDS-DOCKL-SAM62CPU

Locking GDS® Tough-Dock™ with USB Type-C for Tab Active3 & 2

RAM-VENT1-RCT-50U

RAM® Vent-Temp™ with Back Dock Connection for Rectangular Vents

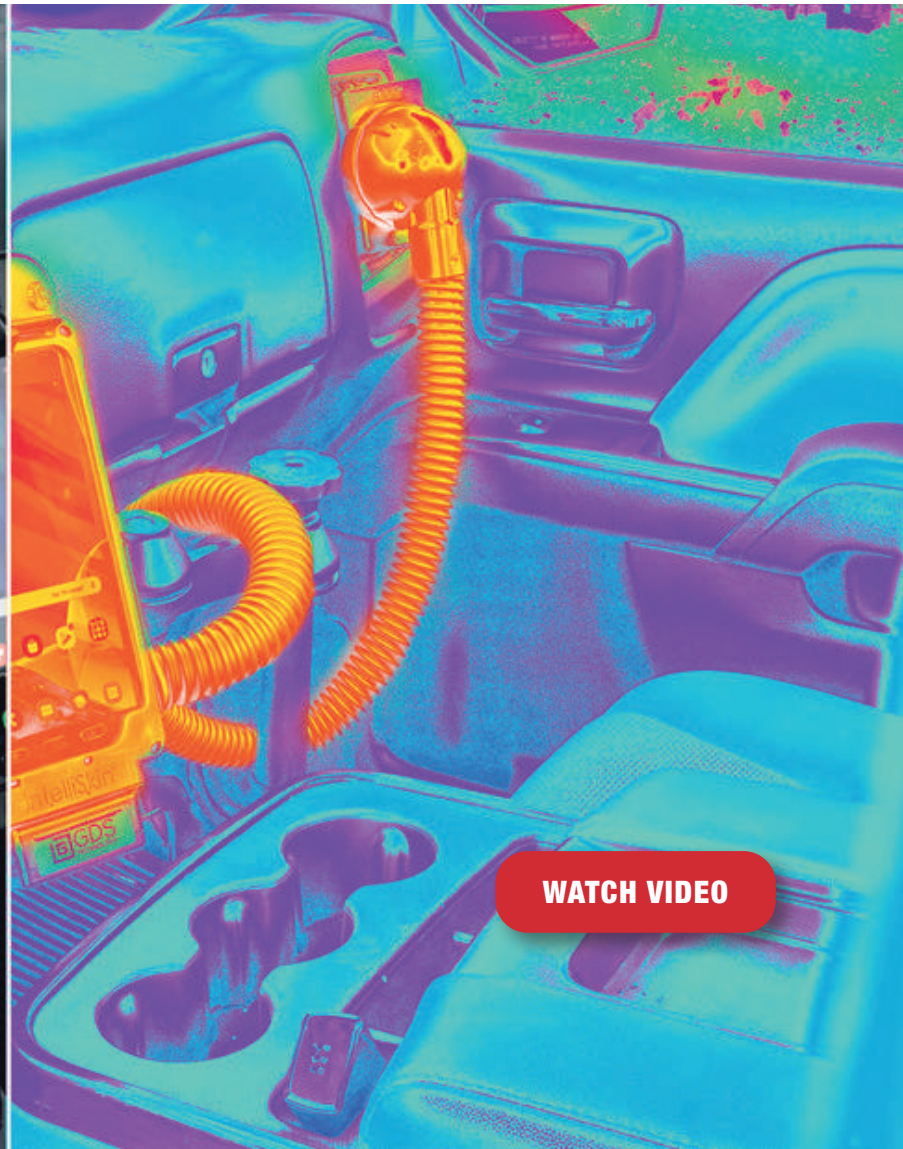

[WATCH VIDEO](#)

ACCESSORIES CONTINUED

Temperature Control Products

An empty housing module is located at the back of your dock, allowing you to upgrade your mounting solution at any time. This housing can accommodate various temperature modules provided by RAM® Mounts. Easily install either the RAM® Vent-Temp™, which connects to your vehicle's A/C vents or the RAM® Temp-Right™, which provides regulated heat in extremely cold environments.

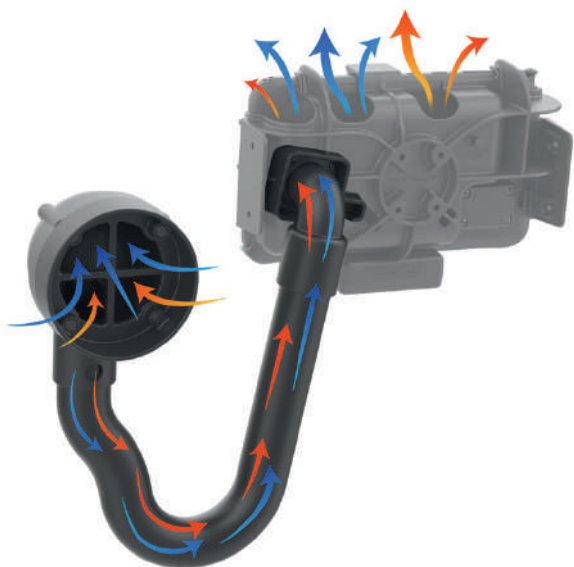

RAM® VENT-TEMP™ BACK NOZZLE ATTACHMENT

Hot or cold air from your vehicle's air system enters through the RAM® Temp-Right™ nozzle, travels through flexible tube, and exits behind the docked tablet.

RAM-VENT1-RCT-50U

RAM® Vent-Temp™ with Back Dock Connection for Rectangular Vents

RAM-VENT1-RND-50U

RAM® Vent-Temp™ with Back Dock Connection for Round Vents

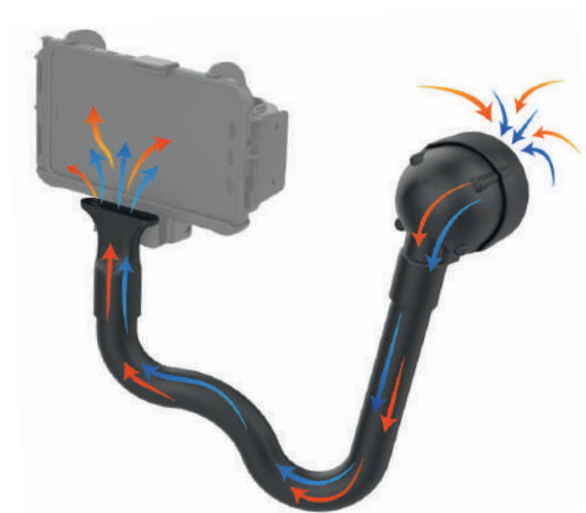

RAM® VENT-TEMP™ FRONT NOZZLE ATTACHMENT

Hot or cold air from your vehicle's air system enters through the RAM® Temp-Right™ nozzle, travels through flexible tube, and exits in front of the docked tablet.

RAM-VENT2-RCT-50U

RAM® Vent-Temp™ with Front Dock Connection for Rectangular Vents

RAM-VENT2-RND-50U

RAM® Vent-Temp™ with Front Dock Connection for Round Vents

FEATURES



Vent cover attaches directly to circular vents using zip ties
Hose attachment includes built-in magnets for easy break-away when not in-use

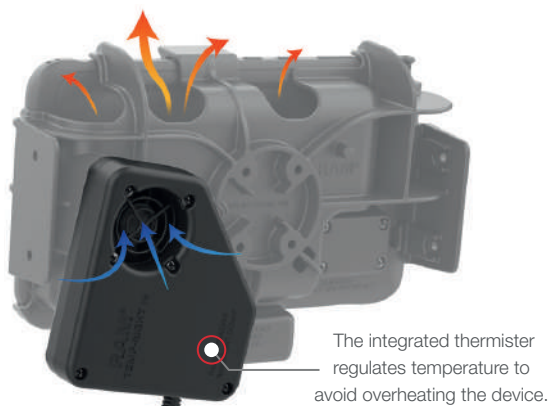

The integrated thermister regulates temperature to avoid overheating the device.

RAM® TEMP-RIGHT™

The RAM® Temp-Right™ heater module regulates device temperatures to maintain functionality in extreme cold environments and contains integrated 11-16VDC hardwire charger. Cabin air gets sucked through Temp-Right™ fan and through the module, heating the air up to the right temperature needed for tablet functionality.

RAM-DOCK-HEATER1-BU

RAM® Temp-Right™ Dock Heating Module for GDS® Tough-Dock™

RAM-DOCK-HEATER1-CU

RAM® Temp-Right™ Dock Heating Module for Samsung Tab Active3

ACCESSORIES CONTINUED

Samsung DeX In-Vehicle



SEEN IN THIS PHOTO:

RAM-VB-196-GDS-EC01

GDS® Ecosystem™ Vehicle Bundle with Monitor, Keyboard & Phone Mount

ACCESSORIES CONTINUED

Samsung DeX In-Vehicle

RAM® Mounts has partnered with Samsung to support the Samsung DeX platform by enabling the system in-vehicle. Samsung DeX allows you to consolidate your workflow through a Samsung phone while RAM® Mounts allows you to transform your vehicle into a mobile workstation with the help of familiar peripherals that emulate a desktop experience.

The GDS® Ecosystem™ Bundle is the all-in-one solution for introducing Samsung DeX into your workflow. This bundle includes a GDS® View™ 13.3" touchscreen monitor, a GDS® Keyboard™, display bracket, universal vehicle mount, phone mount, and hardwire chargers to transform your vehicle into a mobile office. Simply insert your DeX-enabled Samsung phone and connect your device to the workstation so you can work on the go.



RAM-VB-196-GDS-EC01

GDS® Ecosystem™ Vehicle Bundle with Monitor, Keyboard & Phone Mount

ACCESSORIES CONTINUED

Hardwire Chargers



SEEN IN THIS PHOTO

RAM-GDS-CHARGE-V7B1U

GDS® Modular 10-30V
Hardwire Charger with Female
USB Type-A Connector

ACCESSORIES CONTINUED

Hardwire Chargers

Maintain a consistent power connection to your fleet of devices with the GDS® Modular Hardwire Chargers. When it comes time to upgrade, avoid any rewiring by simply unplugging the power connector and attaching the new charger components. As part of the GDS® Reach™ enabled by the GDS® Ecosystem™, our solutions work seamlessly to keep devices protected, connected, and charged in nearly any application.



RAM-GDS-CHARGE-V3C-2U
 GDS® Modular 10-30V Power Delivery Hardwire Charger with Male USB Type-C



RAM-GDS-CHARGE-V3CH-2U
 GDS® Modular 30-64V Power Delivery Hardwire Charger with Male USB Type-C



RAM-GDS-CHARGE-V7CU
 GDS® Modular 10-30V Hardwire Charger with Male USB Type-C



RAM-GDS-CHARGE-V8BU
 GDS® Modular 30-64V Hardwire Charger with Female USB Type-A Connector

Selecting Your Charger

There are two factors to consider when choosing a charger; the charging requirements of your **device and dock** determined by the type of output connector (column 2 below) and the charging requirements of your **vehicle** determined by the input voltage (column 5 below). Cars, trucks and fuel-burning forklifts generally range from 12V to 24V. Electric forklifts generally range from 36V to 48V.

Contact your RAM® Mounts representative to ensure your power supply is compatible with your solution.

HARDWIRE CHARGERS	Output Connector Type	Power Delivery	Legacy USB	Input Voltage	Output Voltage	Input Cable Length	Output Cable Length
RAM-GDS-CHARGE-V3C-2U	USB-C Male	Yes	Yes	10 - 30 VDC	5 - 15 VDC	2.5M	1M
RAM-GDS-CHARGE-V3CH-2U	USB-C Male	Yes	Yes	30 - 64 VDC	5 - 15 VDC	2.5M	1M
RAM-GDS-CHARGE-V7CU	USB-C Male	No	Yes	10 - 30 VDC	5.42 - 9 VDC	2.5M	1M
RAM-GDS-CHARGE-V8CU	USB-C Male	No	Yes	30 - 64 VDC	5.42 - 9 VDC	2.5M	1M
RAM-GDS-CHARGE-V7B1U	USB-A Female	No	Yes	10 - 30 VDC	5 - 9 VDC	1.2M	200mm
RAM-GDS-CHARGE-V8BU	USB-A Female	No	Yes	30 - 64 VDC	5 - 9 VDC	1.2M	200mm

Connecting Your Charger

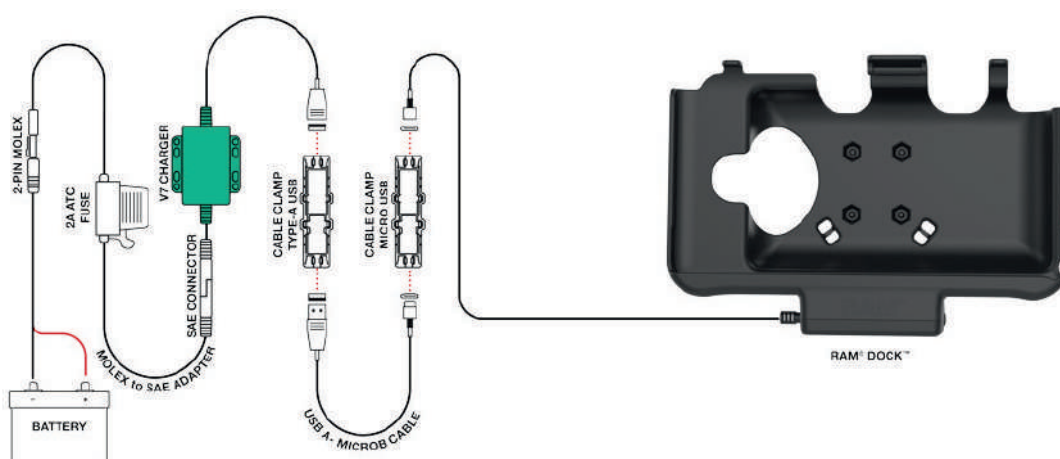

MAINTENANCE

Care & Maintenance



Maintenance

Care and Maintenance

When it comes to protecting and maintaining your fleet of devices, regular care is important for long-term performance. Learn more about our recommended cleaning, care, and maintenance below.



Supplies



CLEANING AGENT + Q-TIPS
Use every 2 weeks



DEOXIT PEN
Use every 6 months



RAM-GDS-BRUSH-01U
IntelliSkin® Contact Brush

1 Tablet Preparation

Remove factory sleeve from tablet. Pogo pads are recessed from the tablet and the protective sleeve, so removing the sleeve is a vital step ahead of cleaning the pogo pads.



General Care & Maintenance

- For spills or accumulated dirt on the GDS® Dock™ pogo pins, gently clean using contact cleaner or alcohol on a cotton swab. Use contact cleaner or alcohol with a stiff brush to clean IntelliSkin® contacts.
- For industrial and heavy use environments, clean pogo pins and contacts on a regular basis.

3-year warranty on all electronic components/Lifetime Warranty on all non-electronic components

The exclusive NPI Lifetime Warranty states that all GDS® non-electronic components and parts are warranted against defect in materials and workmanship for the life of the product or part. NPI's Lifetime Warranty covers the product or its components only. The mount device is not covered under the Lifetime Warranty and will not be replaced if damaged as a result of mount failure. This warranty is expressly limited to persons in the United States, and all foreign countries who purchase GDS® for resale or use in the ordinary course of the buyer's business. This warranty does not cover any product or part that has been abused, worn out, heated, ground or otherwise altered, used for a purchase other than that for which it was intended, or used in a manner inconsistent with any instruction regarding its use.

2 Cleaning

Uncap your DeoxIT® Pen, or wet the end of your Q-tip with the cleaning agent and twist in a circular motion against each pogo pad 2-4 times each pad. Check pad for cleanliness and repeat the process until thoroughly cleaned.

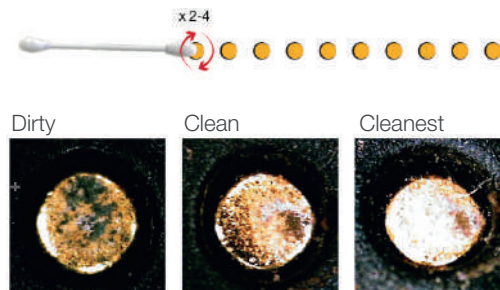
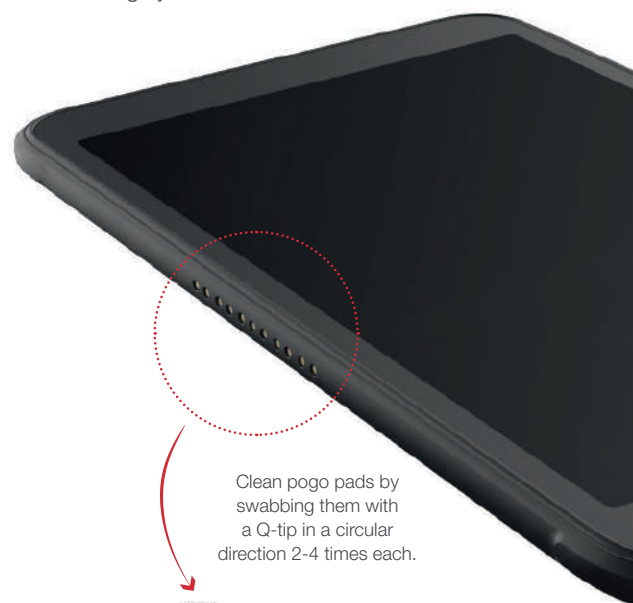



Mount Anything, Anywhere

SAMSUNG



www.rammounts.de
+49 30 917471-70
vertrieb@rammounts.de

Folgen Sie uns:



IntelliSkin®



GDS®
TECH™

GDS®, IntelliSkin®, GDS® Tech™, GDS® Technology™, GDS® Green™, GDS® Reach™, and GDS® Compatible™ are trademarks or registered trademarks of National Products Inc.

The distinctive D Shape™ of the GDS® connector is a trademark of National Products Inc.

PATENTS AND TRADEMARKS
WWW.RAMMOUNT.COM/IP



RAM® double socket arms with their distinctive Hourglass Shape are recognized globally as a symbol of the reliability, quality, and durability of this line of products. The Hourglass Shape is a registered trademark of National Products Inc.



The distinctive RAM® *X-Grip® product shape is a trademark of National Products Inc.



Look for the highly recognizable "Double Delta" trademark, the symbol of quality and reliability