

# WHEREVER YOU NEED AN IMAGE

MOUNTING SOLUTIONS FOR DISPLAYS & PROJECTORS



WHEREVER  
YOU NEED AN  
IMAGE

Wherever you need an image, we provide smart mounting solutions for displays, projectors and interactive boards.

At SMS we develop and market a great variety of brackets for all sorts of locations, from walls, floors and ceilings to the stage, streets, forests and everywhere else. At every stage, we have listened to our customers, specifically addressed their needs and incorporated them into our product range. And to meet all kinds of requirements, we also create custom solutions so everyone can have it their own way.

**From need to design:** We focus on professional installations indoors and outdoors but also provide solutions for home use. Every product is designed in accordance with user-defined requirements and environments. All of our products share common features: modern design, simple mounting, user friendliness, flexibility, and smooth integration with technology and furnishings.

08  
EDUCATION

14  
CORPORATE &  
CONFERENCE

20  
RETAIL &  
DISPLAY

28  
EVENTS &  
EXHIBITIONS

34  
BROADCASTING  
& CONTROL

38  
HOTEL &  
HOSPITALITY

44  
PUBLIC  
SPACES

50  
HOME  
ENTERTAINMENT

CASINGS.....54    OVERVIEW.....56    SUPPORT.....58

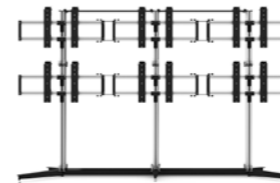

## Custom solutions – Installing the image

We look at the end results, not just the nuts and bolts.

We believe every place should have the best possible installation that fits the customer's schedule and budget. Over time, we have been able to offer a surprising range of alternatives that result in equally surprising budget efficiency and delivery schedules.

For instance, we have seen that critical individual components must be interchangeable to allow the product to meet new demands for function and aesthetics. Our solutions consist of proven components with the desired functionality, which are combined and adapted to meet unique requirements. This ensures proven and exact functionality, cost-effective development and a noticeably shorter delivery

schedule than typical "custom made" solutions.

Through the years we have developed thousands of exciting and new solutions at the request of, and in close collaboration with, our customers.

### Branding: Customizing the look and feel

Through the years we have considered the look and feel as well. It must fit in with the surroundings, the building, the city, and, in most cases, it must also strengthen the customers' brand. Since we work with this in mind, the customer can modify the products in our production line, adding specific color schemes and cover materials without delaying delivery times or increasing costs.



### Custom solutions: Stockholm Central Station

When the decision was made to install digital signage in the Swedish capital's travel center from the 19th century, some were concerned that

that the equipment would clash with the largely wooden interior. The solution was to customize indoor media cabinets with a wood foil covering. That adjustment only took an additional week to complete.



**SMS MEDIA CABINET  
INDOOR TOTEM**  
Adapted with wooden foil to fit the 19th century interior of Stockholm Central Station.  
Photo: Jernhusen Media

SMS UNISLIDE



EDUCATION

# Great ergonomics makes learning easier and faster

We support teaching and learning with easy adjustment, mobility and good viewing conditions for everyone.

The trend is moving towards less projectors and screens and more large displays and touch displays. It is a compact solution that provides more scope for interactivity. But it also means that ergonomics is growing more important.

In our range SMS Short Throw Wall Manual is a bracket for projectors and interactive boards and Presence Wall Manual is a bracket for heavy screens and touch displays.

A common feature in both is that

you can quickly and easily adjust the height of displays to suit different users, like students who want to approach an interactive board. With our patented Spring Counter Balance System, all it takes is a light touch.

With SMS Presence Mobile, you can bring a complete display system with you if you change classrooms or lecture halls. Large wheels and a wide platform provide easy and safe transport for large and heavy displays.



### Good to know: Interaction works

A study carried out at Manchester Metropolitan University showed that students using an interactive screen while attending courses on three major subjects achieved an educational advantage of several months over students who did not.



### Patent-pending solution

The Presence Wall Manual is a patent-pending solution with an ingenious locking mechanism that

ensures the display is held in exactly the right position, thus providing easy access for all users.

### Custom solution: Hungarian schools

Conference Techniques Limited needed a flexible and fixed bracket that fit a tight school budget. To meet the requirements, we simplified the SMS Projector Short Throw Wall; this brought interactive screens to 700 Hungarian classrooms.



### SMS SHORT THROW MANUAL

When you pull the handle up or down, the patented low-friction design ensures that the interactive board moves nearly by itself. The universal fitting can be used with most currently available boards.

**SMS PRESENCE**  
 MOBILE MOTORIZED  
 Perfect for large and heavy displays that require easy transport between classrooms or lecture halls. For displays up to 120 kg.



**FUNC**  
 MOBILE MOTORIZED  
 A very stable design, perfect for large heavy displays and touch-sensitive displays. The motorized height adjustment ensures the user to present or interact with the display in an ergonomic position. Thanks to the wheels, it is easy to move the unit between different rooms.



**SMS PROJECTOR PRECISION**  
 CM V  
 Keeps projectors up to 20 kg in the right position at any height. Extend the telescopic arm to your preferred length and adjust the image simply and accurately.



**SMS PROJECTOR PRECISION**  
 PRO  
 A ceiling bracket for really heavy projectors up to 30 kg. Get the perfect image with easy-to-use forward and backward tilt control and left/right rotation.



**SMS PROJECTOR**  
 SHORT THROW WALL MANUAL  
 Easy to reach for children, grown-ups and disabled persons, making interactivity accessible for everyone.

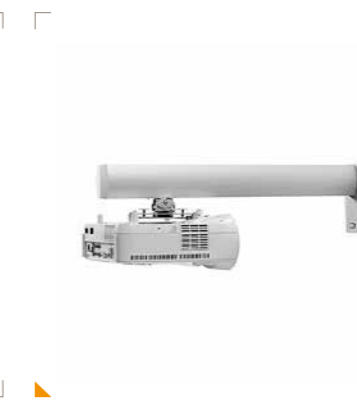

**SMS PROJECTOR**  
 SHORT THROW V  
 Easy to mount close to the ceiling. The projector can also be suspended, swiveled and tilted at any location along the arm.



**SMS PROJECTOR**  
 SHORT THROW V+  
 All light on the projection screen, not in the speaker's eyes. With extensive adjustment options to obtain the best possible image quality in all positions.

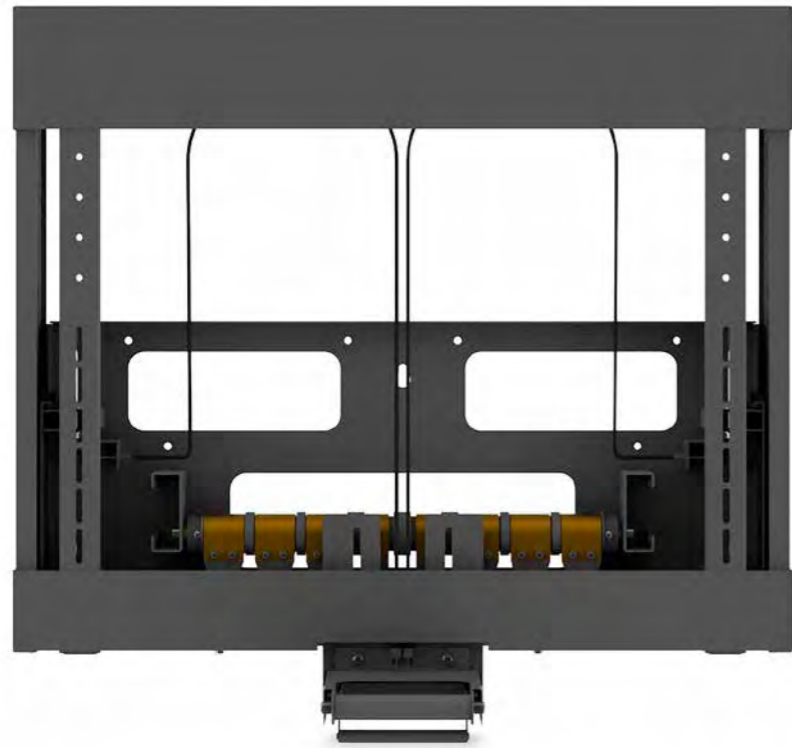

CORPORATE  
& CONFERENCE



## Let your equipment carry the load

We support image-building and individual ergonomics with adjustable and sharp-looking equipment.

An office plays an important part in how a company's image is conveyed. A smart-looking environment sends a clear message to clients, suppliers as well as current and potential employees. Part of that message is ergonomics. All equipment must be easy to adjust for the individual user. For this reason, we have developed a range of single and multiscreen solutions and

mobile stands for displays and interactive boards.

Our range delivers the following to your conference room: height-adjustable equipment that is easy to move, a design with hidden cables and peripherals that is attractive from all angles and equipment that is stable, precise and holds heavy displays and projectors in place without readjustment.



### Good to know:

#### A surge in virtual meetings

Fuelled by the interest in saving money and decreasing CO2 emissions, videoconferencing is steadily increasing in popularity and the market for practical equipment is growing. According to the Washington Post, the demand for AT&T's video and teleconferencing service for federal clients increased by about 20 percent during the first half of 2013 alone.

One of the reasons is the "Cut the Waste, Stay in Place Act" of 2013 which aims to use videoconferencing to cut federal agency travel spending in half by 2017, saving about \$15 billion. One example is NASA, where all but the most mission-critical conferences are not permitted if they are further than a Metro ride away. In July 2013, NASA held its first Google+ Hangout news briefing on its Interstellar Boundary Explorer satellite.



**SMS PRESENCE**  
VIDEO CONFERENCE  
Stable, attractive and  
easy to move.

### SMS PRESENCE: FIXED OR ADJUSTABLE HEIGHT?

The Presence range offers a patented, stable and elegant design for heavy and large displays for video, touch, interactivity etc. The Mobile version is designed with the height set for seated participants. The Mobile Motorized version combines both options, so you can adjust the display to suit both standing and seated participants. The motorized height adjustment is soft, quiet and readily available from a button on the side of the unit, behind the display. Our motorized products can be remotely controlled in elevation, using the wireless SMS Remote Control Kit.



**SMS PRESENCE VIDEO CONFERENCE**  
A unique design that is attractive from all angles and which completely hides cables and peripherals inside the unit. For displays up to 2x55 kg (total 110 kg).

**SMS PRESENCE MOBILE**  
Perfect for large, heavy and touch-sensitive displays. Easy to move and attractive from all angles. For displays up to 120 kg.

**SMS PROJECTOR SHORT THROW V+**  
All light on the projection screen, not in the speaker's eyes. With extensive adjustment options to obtain the best possible image quality in all positions.



**SMS PRESENCE VIDEO CONFERENCE MOTORIZED**  
A patented and elegant design with a soft and quiet motorized height adjustment readily available from a button on the side. For displays up to 2x55 kg (total 110 kg).

**SMS PRESENCE MOBILE MOTORIZED**  
The motorized height adjustment is soft, quiet and readily available from a button behind the display. For displays up to 120 kg.

**SMS PROJECTOR SHORT THROW V**  
Easy to mount close to the ceiling, this projector can be suspended, swiveled and tilted at any location along the arm.

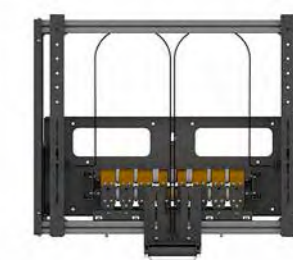

**SMS SLIM FLEX, FIXED, SWING**  
The SMS Slim range offers some of the thinnest brackets in the world for thin LED-backlit LCD displays. Slim Fixed, the thinnest alternative, extends from the wall by only 5 mm. With SMS Slim Flex, the user can tilt displays up to 30 kg with a light touch. The Slim Swing combines close-to-the-wall mounting with a highly flexible bracket arm.

**SMS PRESENCE WALL MANUAL**  
Simple and discrete height adjustment, with an ingenious patent-pending locking mechanism that ensures the display is held in exactly the right position.



**SMS PROJECTOR PRECISION CM F**  
Universal bracket for projectors up to 20 kg. Fine adjustment, including tilt, is made directly from the projector bracket, without the need for any tools.

**SMS PROJECTOR PRECISION CM V**  
Keeps projectors up to 20 kg in the right position at any height. Extend the telescopic arm to your preferred length and adjust the image simply and accurately.

**SMS PROJECTOR PRECISION PRO**  
A ceiling bracket for projectors up to 30 kg. The rotatable ceiling plate and the concealed cable feed in the column make installation both simple and discreet.

SMS MULTI DISPLAY WALL PRO

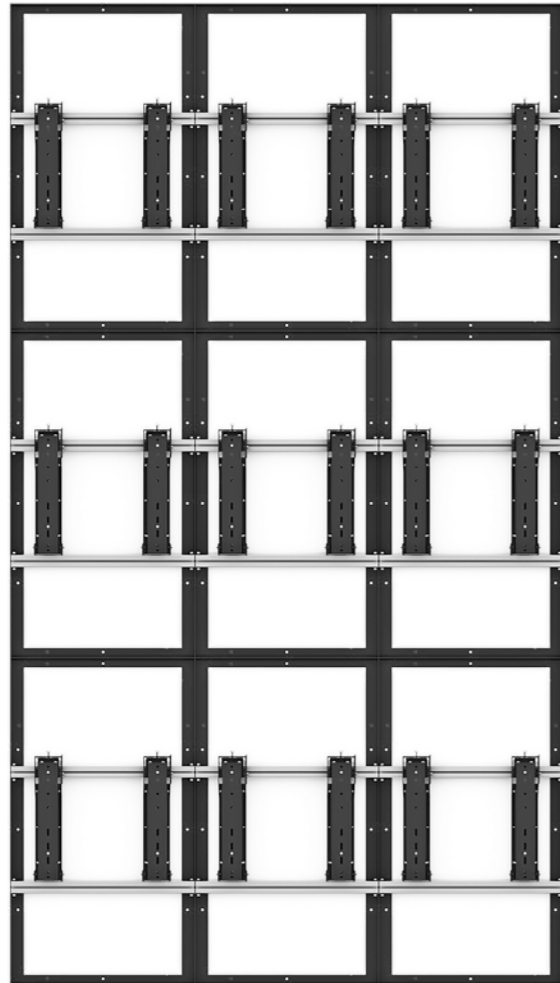

RETAIL &  
DISPLAY



**SMS**  
FRONT CASINGS  
Easy to mount at a fixed  
tilt – for people who want a  
perfect viewing angle. Here  
at McDonald's Hamngatan  
in Stockholm.

## Great products deserve a great digital sign

We provide entrepreneurs with flexible digital signage to inform and inspire customers on the go.

For shops, food stores, malls, restaurants and other venues which deal with the public, all forms of market exposure are potential sales leads. With SMS, you can place digital signage at exactly the right spot to reach the customers where they are, with the right message – and change the message to suit the moment.

With SMS it's easy to inspire from shop windows, on columns and on walls. Set up directed individual screens or complete video rows. A triangular screen solution in a high traffic area allows your image to reach visitors regardless of the direction they come from. Use flexible floor stands or present your message from a distance using a video wall.

### Digital signage indoor – two products

We offer ready-to-use enclosures for the most popular screen sizes 40, 46 and 55 inches, for all indoor communication.

SMS Media Cabinet Indoor Wall can be mounted on walls, pillars and similar locations. Its sister product, the SMS Media Cabinet Indoor Totem, is in a floorstanding format, securely bolted down. Both offer highly flexible mounting, and the Totem can be mounted with displays back-to-back in pairs.

The Media Cabinets are extremely cost-effective, since they are partially pre-assembled and it is easy to change the various components.



**SMS MEDIA CABINET  
INDOOR WALL**  
Stylish, slim and secure  
digital signage for indoor  
public environments  
such as train stations or  
shopping malls.

**SMS MULTI DISPLAY WALL** A simple way of building a video wall or mounting several screens in a row. Simply choose as many modules as you need. Each module is supplied as a complete package with all necessary components, and can be set up in three easy steps. The solution makes it easy to align the screens exactly and mount them edge-to-edge. The final result lies closer to the wall than most other products on the market.



For extra fast and accurate mounting.

Launch fall 2014.

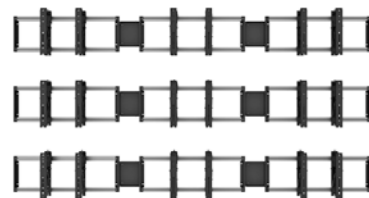

**SMS MULTI DISPLAY WALL PRO 2.0**

The updated version of SMS Multi Display Wall PRO has a universal solution that fits displays from 46" to 60". The unique combination of the push and slide service function allows for easy access to the 6 point fine adjustment for a perfect end result.

**SMS MULTI DISPLAY WALL PORTRAIT**

Mount large screens up to 70" close to the wall in portrait mode.

**SMS MULTI DISPLAY WALL XL**

Mount screens 70"-82" in landscape mode, portrait mode or in rows.



**SMS MULTI DISPLAY WALL+**

The "push" function lifts one screen while the others remain in operation.

**SMS MULTI DISPLAY WALL**

A cost-effective and simple way of building a video wall or mounting several screens in a row. Simply choose as many modules as you need.

**SMS MULTI DISPLAY WALL TILT**

Easy to mount at a fixed tilt – for those who want the perfect viewing angle when mounting large screens in a row, really close to the wall.



**SMS MULTI DISPLAY CEILING DOUBLE**

A flexible solution for spaces where people approach from several directions – the displays may be placed in any direction.

**SMS MULTI DISPLAY CEILING TRIANGLE**

Three perfectly aligned displays – with stepless adjustment for an exact alignment edge-to-edge.

**SMS MULTI DISPLAY CEILING SQUARE**

An optimal and very flexible solution for hanging very large screens to cover all directions. Portrait or landscape mounting.

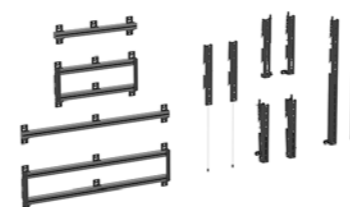

**SMS LFD MODULES PRO**

A professional modular system, developed to offer tailored solutions for single displays up to VESA 900 x 900 and 200 kg. Mix and match to find the perfect solution to fit your exact requirements. Stable, even for very large displays, and, of course, with options for tilt or no tilt.

**SMS FLATSCREEN X CH SD**

A ceiling bracket where two screens are placed back-to-back in vertical or horizontal positions along the column.

**SMS MEDIA CABINET INDOOR TOTEM**

Protected messages in one or two directions from a highly reliable format that can blend into any surroundings.

SMS RAPID

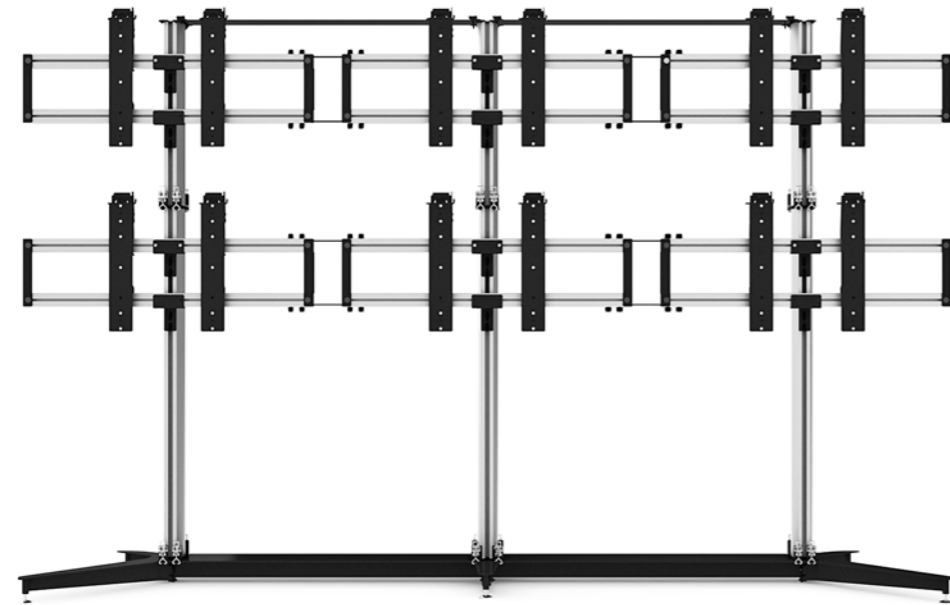

EVENTS &  
EXHIBITIONS

## Make an impact from all angles

We support creative people everywhere with flexible, striking and easy solutions for reaching an audience.

Exhibitions and temporary installations place the focus on mounting, flexibility and solutions that reach visitors in several directions.

With SMS, it's easy to assemble and disassemble and reuse a video wall. And we offer many possibilities for getting your message across in

**Special features:**

**Temporary video walls**

SMS Rapid (page 32) is a cost-effective way to build mobile video walls to be brought on site. Easy click-on attachments make it easy to assemble, disassemble and reuse.

A practical wooden crate is included for easy transport between events and there are several configurations to choose from. A smart solution for rental businesses.

**SMS CUSTOM MADE SOLUTION FOR SHARP**

A creative idea was possible to realize, thanks to the flexible mounting solution of SMS Multi Display Wall +, tailor-made to fit Sharp.

Photo: Sharp





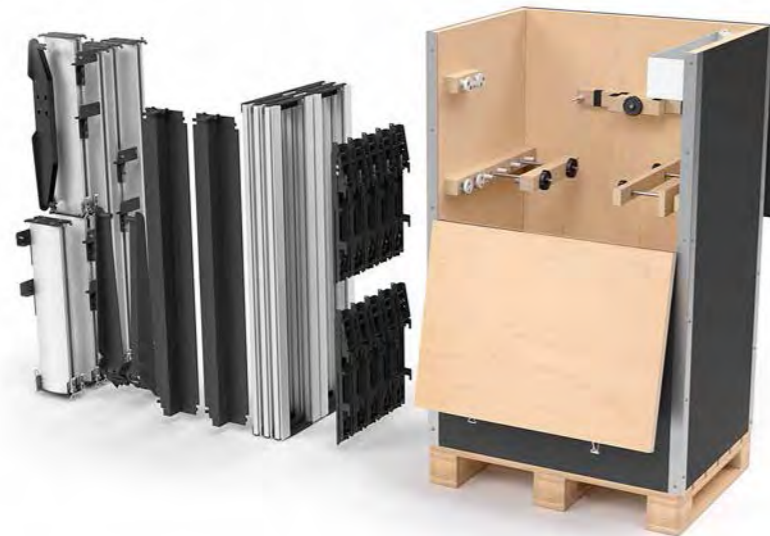

**SMS RAPID**

Now you see it, now you don't. Designed to be quick and easy to assemble, move and reuse. Perfect for rental businesses.

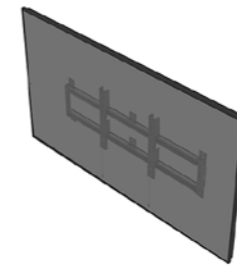

**SMS LFD MODULES  
PRO**

A professional modular system, developed to offer tailored solutions for single large and heavy displays up to VESA 900 x 900 and 200 kg. Mix and match to fit your project.



**SMS PRESENCE  
MOBILE**

Perfect for large and heavy displays that must be easy to move and attractive from all angles. For displays up to 120 kg.



**SMS MEDIA CABINET  
INDOOR WALL**

Stylish, slim and secure digital signage for indoor communication in public areas such as entrances, lobbies, bars and restaurants.



**SMS MEDIA CABINET  
INDOOR TOTEM**

Protected messages in one or two directions with high reliability and the ability to blend into any surroundings.



**SMS PROJECTOR  
PRECISION PRO**

A ceiling bracket for projectors up to 30 kg. Get the perfect image with easy-to-use forward and backward tilt control and left/right rotation.



**SMS PROJECTOR  
PRECISION CM F**

Universal bracket for projectors up to 20 kg. Fine adjustment, including tilt, is made directly from the projector bracket, without the need for any tools.

SMS MULTI CONTROL



BROADCASTING  
& CONTROL

**SMS MULTI CONTROL**  
This multiscreen solution offers nearly unlimited possibilities for everyone who needs an exceptional overview.

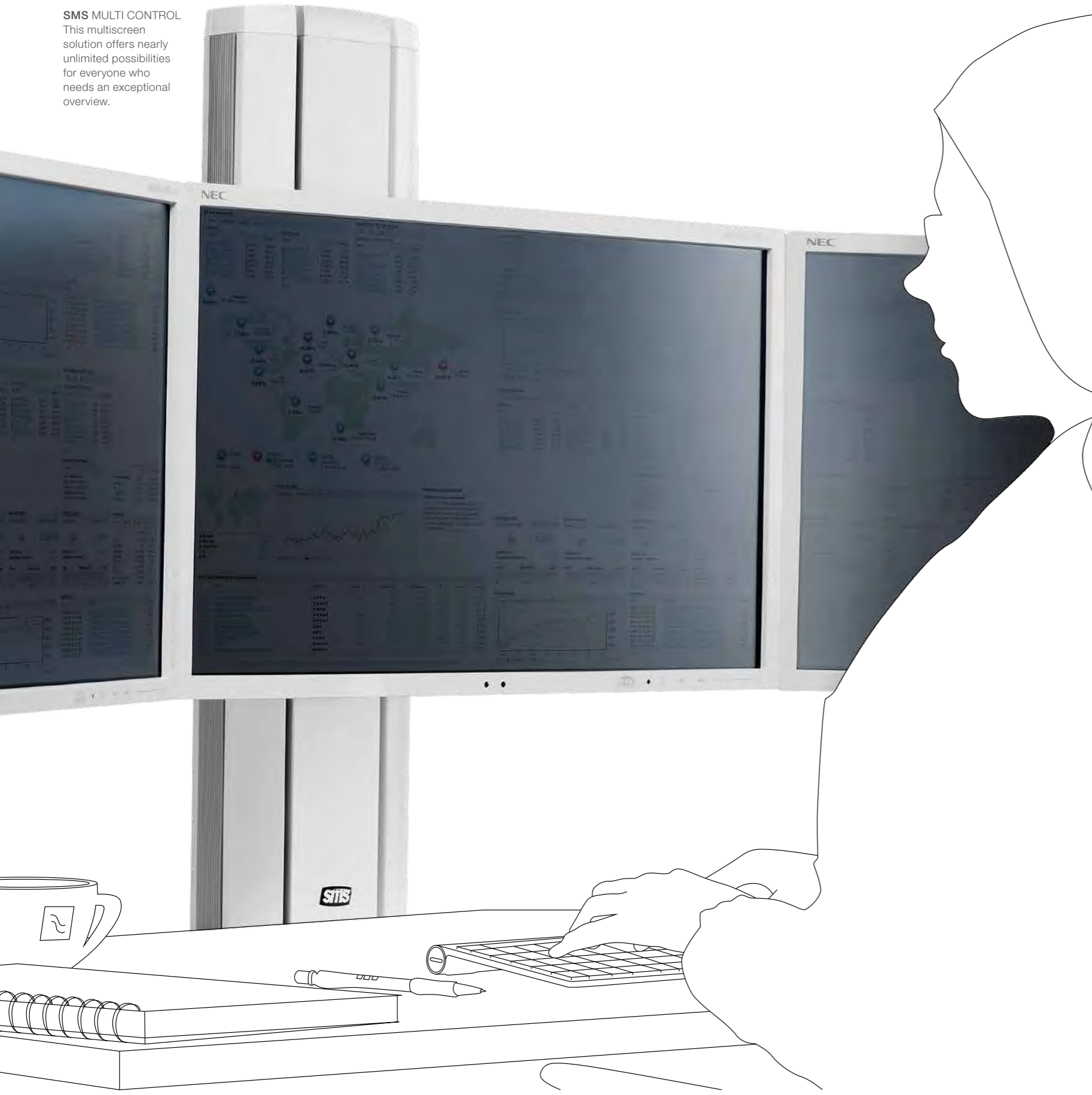

## Working behind the screens

We support professionals in broadcasting, TV and film with the control and ergonomics they need to give us their very best.

Long hours, stress and everyone expecting your full concentration and attention. It's easy to forget that your neck, back and shoulders were not designed for a life in a studio or on a film set. But at SMS, we remember.

When you move, the media equipment should be designed to move with you. A useful feature in

the studio might be a mobile stand that keeps the screen at the right height to comfortably go through takes together.

While you are working, the equipment should be designed to give you maximum coverage in a single glance, without needing to spin around. This is possible with our different solutions for multi-display walls, ceiling brackets and mobile displays.



### Special features: Multi Control

The SMS Multi Control gives you a panoramic view of news, scenes or stock prices at a glance. Or it can form the center of a control room. Choose the number of screens and how they are arranged. Configurations range from two to eight screens in two rows.



### SMS Multi Display Wall

A modular solution that makes it easy to install screens in a row or as a video wall. Simply choose as many modules as you need for screens up to 82".

SMS MEDIA CABINET  
INDOOR TOTEM



HOTEL &  
HOSPITALITY

## Happiness is the right information, at the right moment

We support hotels, bars and facilities with solutions that makes smart places look even smarter.

The great challenge is to serve demanding guests with the details that count. From ingenious fixtures for screens in hotel rooms to attractive and elegant solutions for restaurants, conference facilities and lobbies.

Many guests and visitors expect real-time information on screen, where they are, when they need it. SMS provides a range of adjustable brackets and multiscreen solutions for the reception, lobby, spa,

breakfast room and other marketing areas.

In hotel rooms even the largest displays can be mounted perfectly using of close-to-the-wall, well integrated solutions. We have products to fit all nooks and crannies. In the conference area, guests expect facilities to at least meet the standard of their own office. With SMS, they can have their presentation or video-conference on the largest possible display – mobile and motorized.



### Digital signage: What's on the menu?

With our range of media cabinets, it's easy to find a practical solution for presenting menus, gym hours or conference schedules.

### Custom solution: Radisson Blu WaterFront Hotel

The new hotel wanted to conceal cables and media boxes that were visible behind the screens in 414 rooms. The solution developed was a wall bracket that, in one single piece, fills the space between the screen and the wall and "boxes in" the cables and media box.



RADISSON BLUE  
WATERFRONT HOTEL  
A one solution for  
hiding everything  
behind the screen.



**SMS MEDIA CABINET**

**INDOOR WALL**

Stylish, slim and secure digital signage for indoor public environments such as hotel lobbies, in-house shops, gyms or conference facilities. Discreetly blends into different surroundings. For LED backlit LCD displays with sizes 40/46/55/65/70".



**SMS PRESENCE**

**VIDEO CONFERENCE MOTORIZED**

Attractive from all angles, the unique design completely hides cables and peripherals inside the product. Soft and quiet motorized height adjustment is readily available from a button on the side. A camera shelf is included. For displays up to 2x55 kg (total 110 kg).

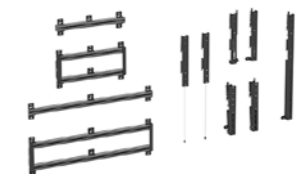

**SMS LFD MODULES**

**PRO**

A professional modular system for single displays, based on our insights from SMS Multidisplay Wall. For displays up to VESA 900 and 200 kg. With options for landscape or portrait mode, tilting or no tilting. Mix and match, choose the modules that match your needs!



**SMS IP CABINETS**

A new generation of Media Cabinets, designed for outdoor or semi-outdoor use. A cabinet that can handle, rough locations and great variations in climate. Created in aluminum to reduce weight and make installation easier. Dust and water resistant, vandalproof.

**Version 1:** 0 to +35°C, **Version 2:** -30 to +35°C, **Version 3:** 0 to +55°C, **Size:** 55". Will be complemented with more sizes.



**SMS PROJECTOR**

**PRECISION CM F**

Universal bracket for projectors up to 20 kg. Fine adjustment, including tilt, is made directly from the projector bracket, without the need for any tools.



**SMS PROJECTOR**

**PRECISION CM V**

Keeps projectors up to 20 kg in the right position at any height. Extend the telescopic arm to your preferred length and adjust the image simply and accurately.



**SMS PROJECTOR**

**PRECISION PRO**

A ceiling bracket for really heavy projectors up to 30 kg. Get the perfect image with easy-to-use forward and backward tilt control and left/right rotation.

SMS MULTI DISPLAY  
WALL PRO

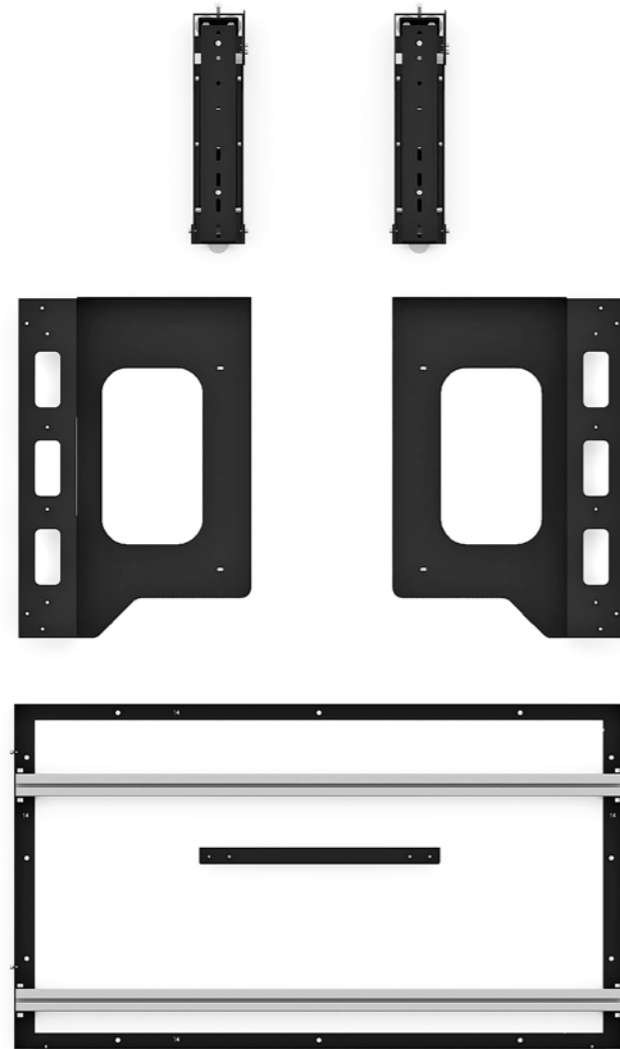

PUBLIC  
SPACES

**SMS MULTI DISPLAY**

**CEILING SQUARE**

Lightweight "Jumbotron" where four displays are placed behind unbreakable Hammergeglass. Also suitable for concert halls, restaurants, bars, trade fairs and events.



# Digital signage that can walk the walk

We provide communities with effective and elegant solutions that work in harsh conditions.

Public spaces belong to everyone and no one. The demand is great for smart digital signage from all angles, but wear and tear are important factors. All the technology has to work, all the time, every time. SMS offers complete and proven solutions for public areas: indoor and outdoors.

In environments like train stations and airports, you can blend into the surroundings with discreet video rows or choose a robust and

elegant solution that encapsulates the screen. In large indoor areas, a floor stand that communicates in several directions may be effective in, for example, commercial premises.

In stadiums and on city streets you can provide information effectively using of several screens mounted in a row. Or for extra high security, choose our encapsulated solutions for indoor or outdoor use.



**Special features:**

**Video wall with "Push"-function**  
SMS Multi Display Wall+ is a modular solution that makes it easy to install screens in a row or as a video wall. The modules allow edge-to-edge mounting and image alignment. The SMS Multi Display Wall+ has a "push" function that allows service on an individual screen while the others are in use.



**Special features:**

**Digital Signage for all weathers**  
SMS Media Cabinet Outdoor is designed from scratch to withstand freezing cold, heat and rain. It includes thermostat-controlled heating and cooling, unbreakable Hammergeglass and a drill-proof lock. Hammergeglass is an unbreakable polycarbonate material, 300 times stronger than glass. It can withstand most types of chemical and acid attacks. UV protection prevents the glass from becoming cloudy or faded.





weatherproof  
launch winter  
2014/2015



**SMS IP CABINETS WALL**

A new generation of Media Cabinets, designed for outdoor or semi-outdoor use. A cabinet that can cope with dust, rough placings and great variations in climate. Created in aluminum to reduce weight and make installation easier. Dust and water resistant, vandalproof. **Version 1:** 0 to +35°C, **Version 2:** -30 to +35°C, **Version 3:** 0 to +55°C, **Size:** 55" Will be complemented with more sizes.

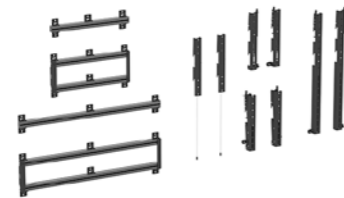

**SMS MEDIA CABINET  
INDOOR WALL**

Stylish, slim and secure digital signage for indoor public environments such as train stations or shopping malls.

**SMS LFD MODULES  
PRO**

A professional modular system for single displays. For displays up to VESA 900 and 200kg. With options for landscape or portrait mode, tilting or no tilting. Mix and match, choose the modules that match your needs!

**SMS MULTI DISPLAY  
WALL PRO**

A professional installer's dream with a unique pull and slide service function that allows for 6 point fine adjustment for a perfect end result.



**SMS MULTI DISPLAY  
WALL**

A cost-effective and simple way of building a video wall or mounting several screens in a row. Simply choose as many modules as you need. Each module is supplied as a complete package with all necessary components, and can be set up in three easy steps. The solution makes it easy to place the screens exactly in line and mount edge-to-edge. The final result lies closer to the wall than most other products on the market.

**SMS MULTI DISPLAY  
WALL+**

The "push" function lifts one screen while the others remain in operation.



**SMS MULTI DISPLAY  
WALL PORTRAIT**

Mount large screens up to 70" close to the wall in portrait mode.

**SMS MULTI DISPLAY  
WALL XL**

Mount screens 70"-82" in landscape mode, portrait mode, or in rows.

**SMS MULTI DISPLAY  
WALL TILT**

For a perfect viewing angle when mounting several screens in a row.

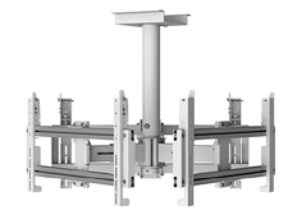
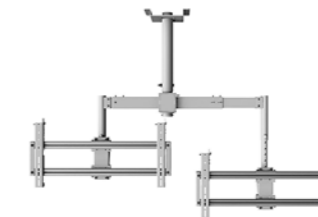

**SMS FLATSCREEN  
X CH SD**

A ceiling bracket where two screens may be placed back-to-back in vertical or horizontal positions along the column.

**SMS MULTI DISPLAY  
CEILING DOUBLE**

A flexible solution for spaces where people approach from several directions – the displays may be placed in any direction.

**SMS MULTI DISPLAY  
CEILING TRIANGLE**

Three perfectly aligned displays – with stepless adjustment for exact alignment edge-to-edge.

SMS SLIM FLEX



HOME  
ENTERTAINMENT

## Delivering big sensations to small places

We support curiosity and relaxation with practical and intuitive installations that everyone can use.

It's a good feeling when you can move the TV around a corner on a flexible bracket arm. It's smart when your home entertainment system can have discreet mounting close to the wall. It's easy when you can attach a projector bracket to the ceiling to create the feeling of a large movie theater. This and many other user-friendly features make exciting and attractive installations accessible to everyone.

### Slim Wall brackets for modern displays

When displays get thinner, the SMS Slim range offers a perfect match with some of the thinnest brackets in the world for thin LED-backlit LCD

displays. The three models are the first that successfully harmonize with the most delicate displays, less than 1 cm thick.

- **SMS Slim Fixed**  
Projects your display up as a poster on the wall – easily and discreetly. The distance from the wall is as little as 5 mm.
- **SMS Slim Swing**  
Close-to-the-wall mounting plus an ability to rotate left and right with a 180° swivel to ensure a perfect viewing angle.
- **SMS Slim Flex**  
With the unique tilt function, the user can tilt displays of up to 30 kg with a light touch.

### SMS SLIM

#### SWING

Always ready to swing 180° to give you the perfect viewing experience.

# We'll do it your way

Our three casing series are developed to make it easy for you to get an installation with your own look and feel. You can order your casing in your brand color, wooden foil – or why not gold? The bottom line is that we can make your casing unique to fit your brand or support your business concept.



### SMS FRONT CASING

- For indoor use
- For branding or customizing the display
- Covers **only front and sides**
- No glass
- Easy to apply foil or coating in different colors
- Sizes: 40"/46"/55"

### SMS COMPLETE CASING

- For indoor use
- For branding or customizing the display
- Covers front, **sides and the back**
- No glass
- Easy to apply foil or coating in different colors
- Sizes: 40"/46"/55"

### SMS TOTEM CASING

- For indoor use
- For branding or customizing the display
- Covers **front, sides and the back**
- Plexiglass or no glass
- Easy to apply foil or coating in different colors
- Sizes: 40"/46"/55"

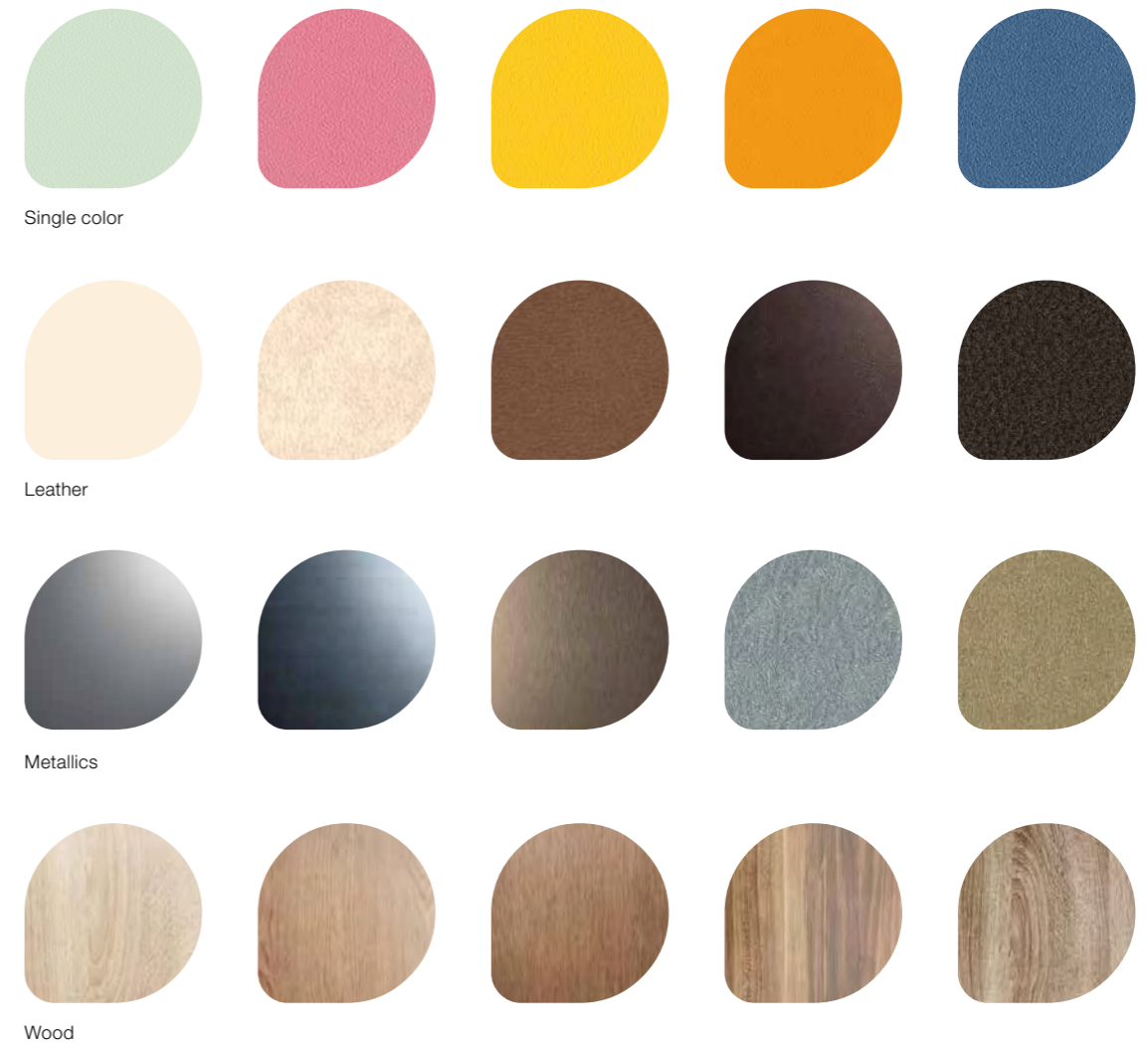

### PICK YOUR CASING

These colors and textures are just our favourites from 3M's vast sortiment. You can choose from a broad range, just let us know what you need.

# Overview product range

We are constantly developing and adding new products to our range. The products below is just a few examples. You'll always get the big picture together with all product details and fact sheets at [smartmediasolutions.se](http://smartmediasolutions.se)

## BRACKETS FOR PROJECTORS



## BRACKETS FOR DISPLAYS



## BRACKETS FOR DISPLAYS



## ACCESSORIES





# We're easy to reach

Are you wondering about where your order is, or do you need information about prices, article numbers, goods in stock or delivery times? Need some advice in selecting a product?

Please contact us – no question is too big or too small.

Send your questions to:  
[support@smartmediasolutions.se](mailto:support@smartmediasolutions.se)

Place your orders at:  
[order@smartmediasolutions.se](mailto:order@smartmediasolutions.se)

Ordering by e-mail is a simple way to place your order directly into our system for faster delivery, without having to worry whether your personal contact is available.

SMS Smart Media Solutions AB  
E-mail: [info@smartmediasolutions.se](mailto:info@smartmediasolutions.se)  
Phone: +46 (0) 8 448 26 60  
Fax: +46 (0) 8 448 26 61

**ADDRESS:**  
Hästholmsvägen 32, 5th flr  
SE-131 30 Nacka, SWEDEN

We reserve the right to introduce changes in product specifications after publication of this catalogue.

[www.smartmediasolutions.se](http://www.smartmediasolutions.se)

[facebook.com/SmartMediaSolutions](https://facebook.com/SmartMediaSolutions)  
 [twitter.com/SMS\\_Official](https://twitter.com/SMS_Official)  
 [linkedin.com/company/sms-smart-media-solutions](https://linkedin.com/company/sms-smart-media-solutions)

# The spirit of SMS

Since the beginning in the 1970s, SMS has stood for Scandinavian design, unique functionality and high quality. We are driven by a pioneering spirit and our work has always involved a great deal of cooperation and innovation. In the long run, and we believe in the long run, that's the best thing we can do to help strengthen our customers' business.

