

viewlite

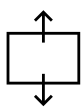

350 mm (13,8")

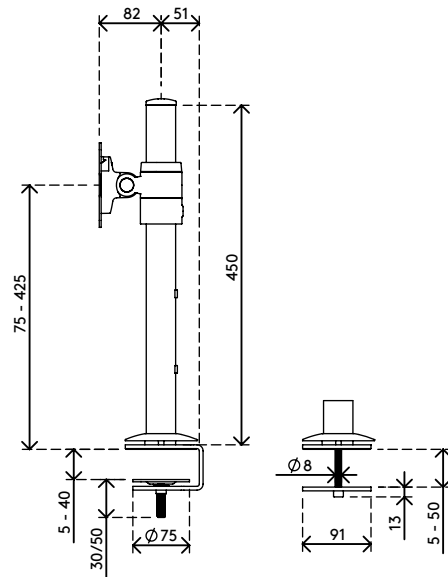
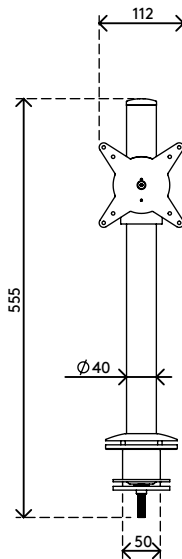
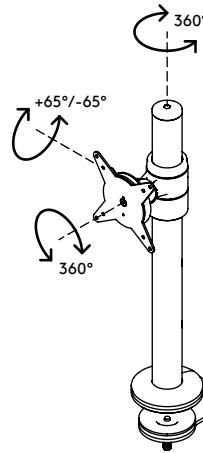
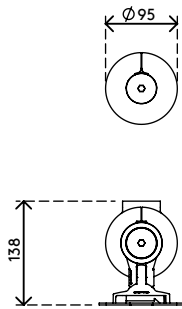

+65°/-65°

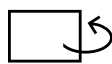

360°



360°



816 mm (32,1")



75/100 mm



8 kg

Viewlite Monitorarm - Schreibtisch 102

2019/06/24

58.102

 610 x 180 x 120 mm

 1 pcs

 silber-Weiß

 3 kg

 805410581022