

# viewlite X

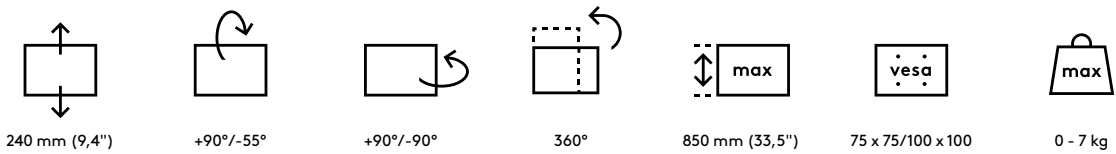
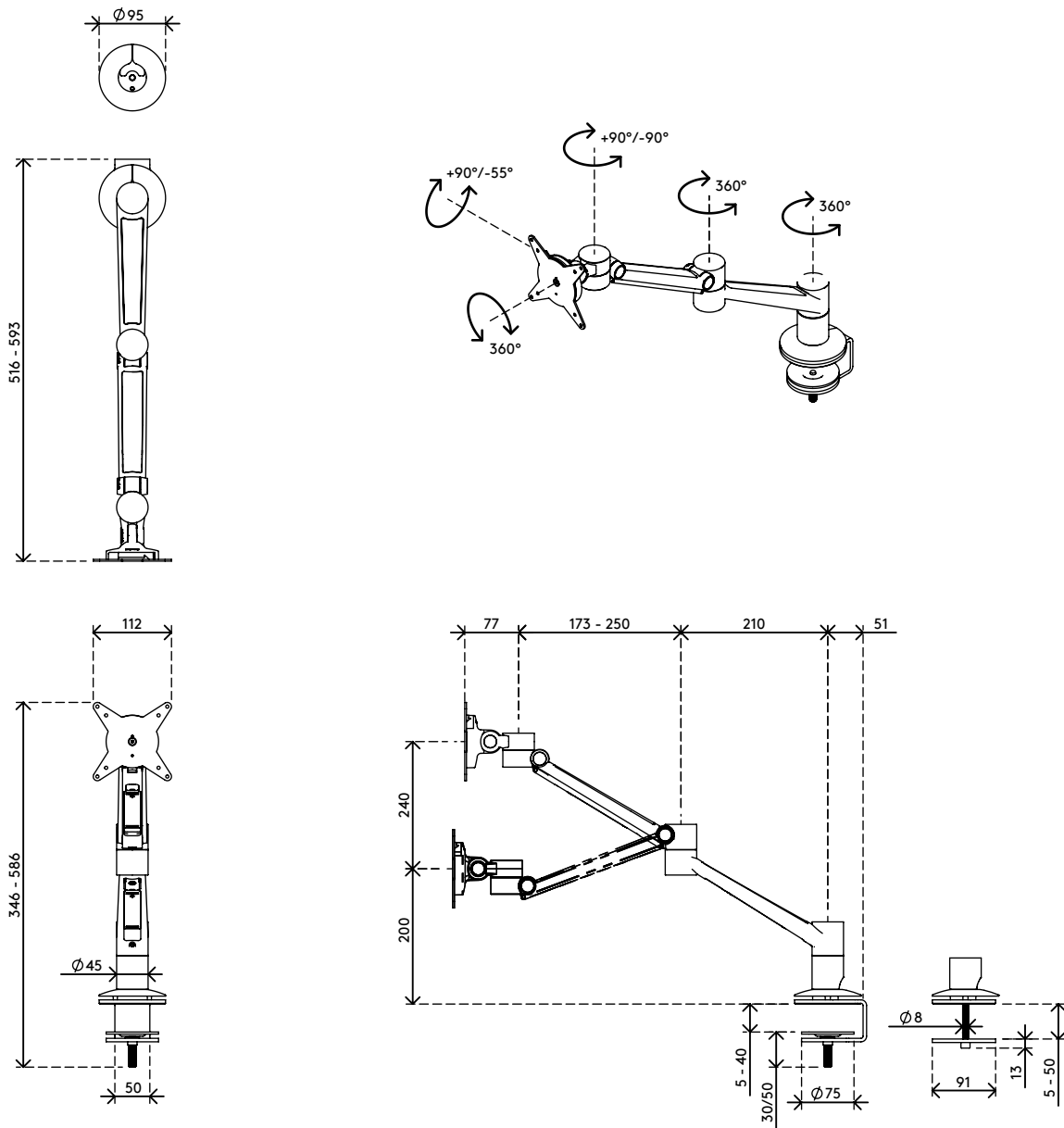

## Viewlite plus Monitorarm - Schreibtisch 622

2019/06/24

# 58.622

375 x 265 x 105 mm

1 pcs

silber-Weiß

3,9 kg

805410586225