

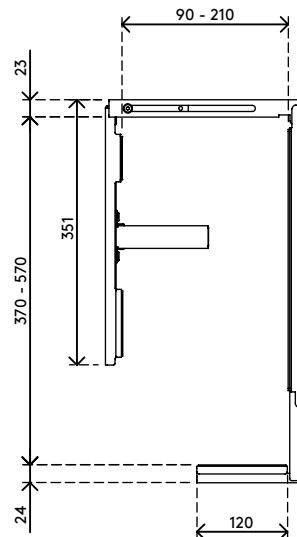

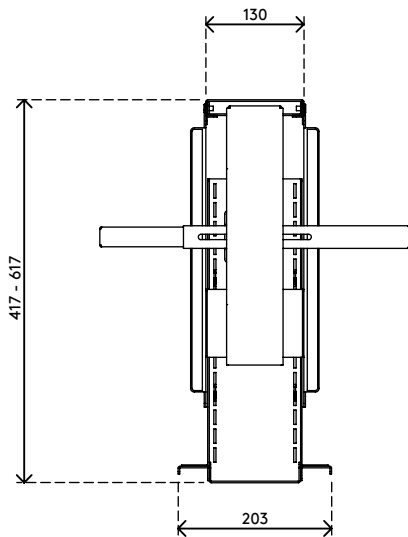

viewmate ^x

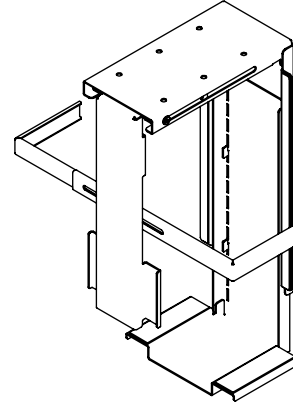
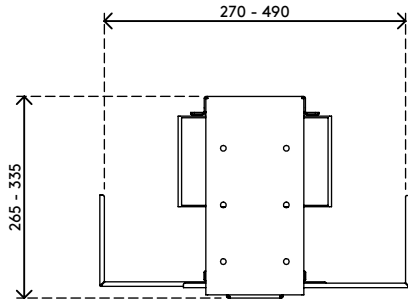
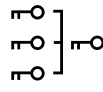
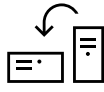

- 
 masterschlüssel
verfügbar
- 
 vertikal
- 
 90 - 210 mm
(3,5 - 8,2")
- 
 370 - 570 mm
(14,5 - 22,4")
- 
 270 - 490 mm
(10,6 - 19,3")
- 
 max
20 kg

Viewmate Computerhalterung - Schreibtisch 302

2019/06/24

32.302

 450 x 200 x 300 mm

 1 pcs

 silber

 4,7 kg

 805410323028