

6

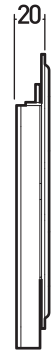
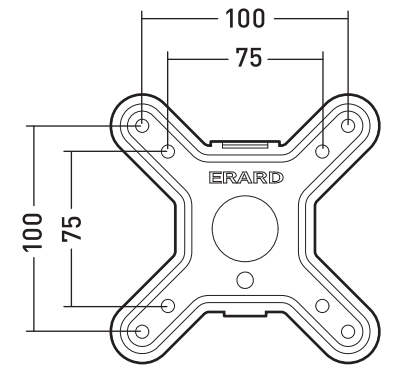
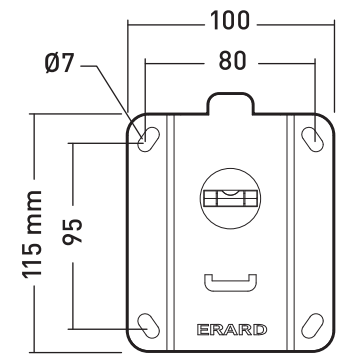
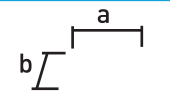
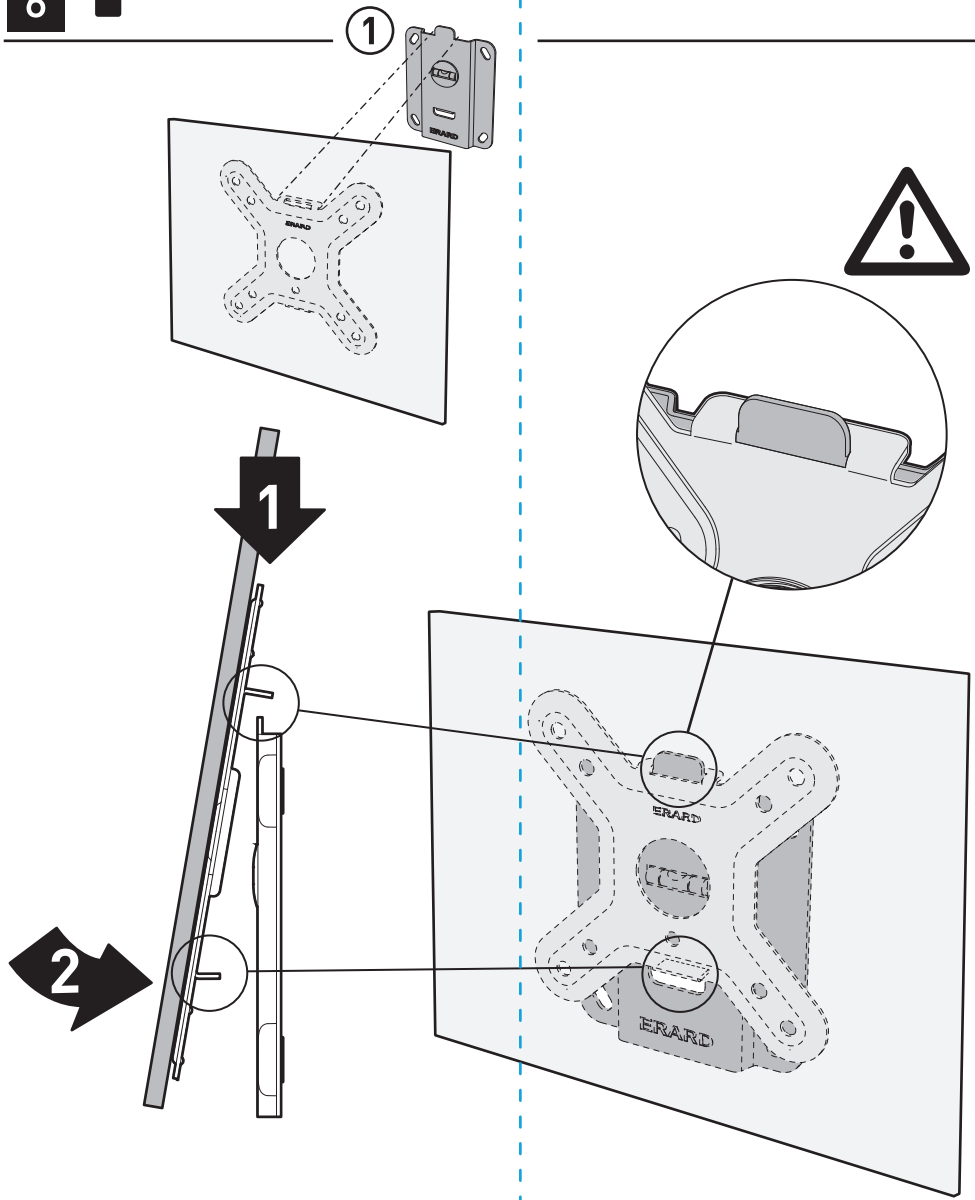

NOTICE CLIFF 100 DVP 120430

CLIFF® 100

SUPPORT MURAL FIXE POUR ECRAN PLAT
FIXED WALL MOUNT FOR FLAT SCREEN



S 15"-23"
38-58cm

15 KG

TESTÉ JUSQU'À 60 KG
TESTED UP TO 60 KG

REF: 043010

Vous avez des questions ?
Vous avez besoin de conseils ?

N° Vert 0 800 40 40 60

APPEL GRATUIT DEPUIS UN POSTE FIXE

international : +33 4 72 46 16 26

Conçu en France - Designed in France

www.erard.com



ERARD®

1



①

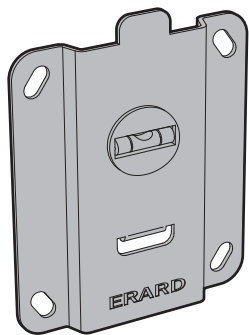

②

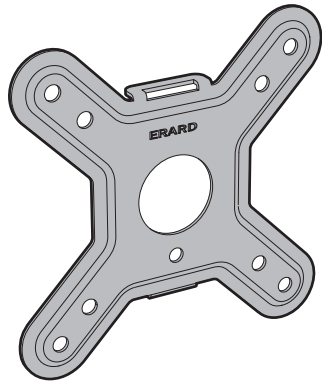

③

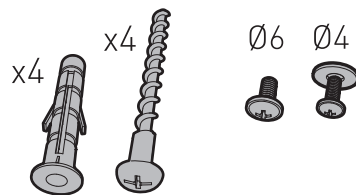
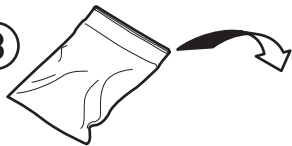

2



①

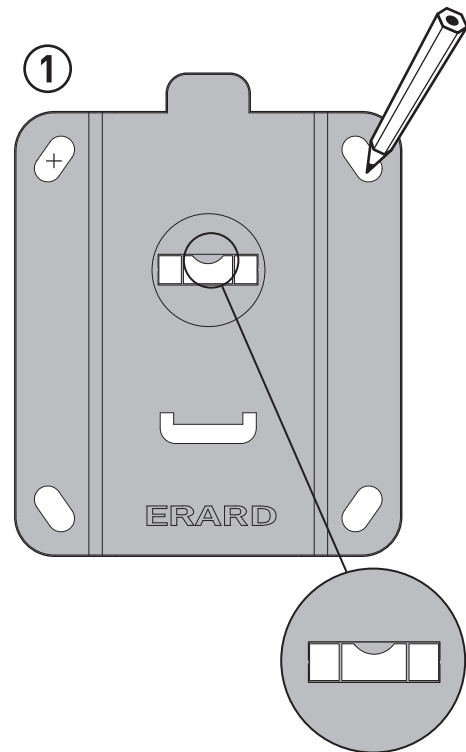

3

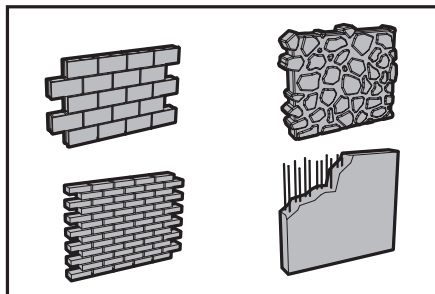

③

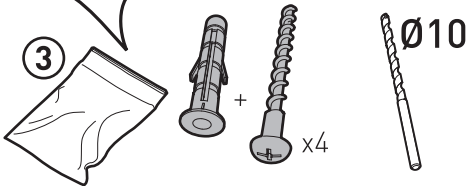

+

+

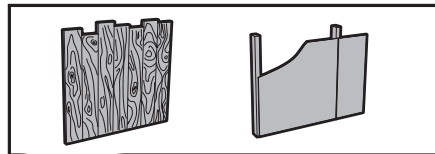

③

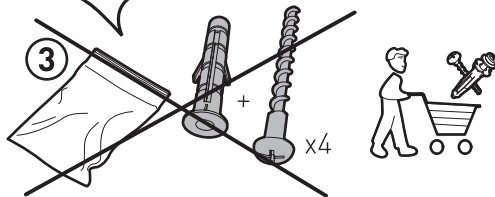

4

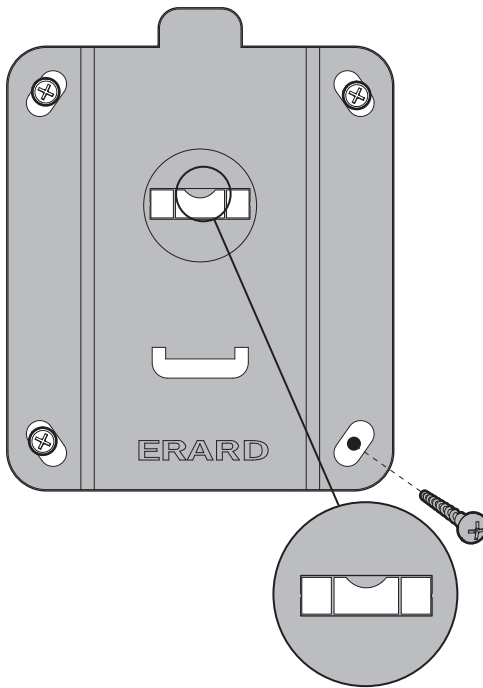
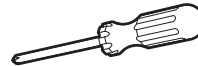

5



③

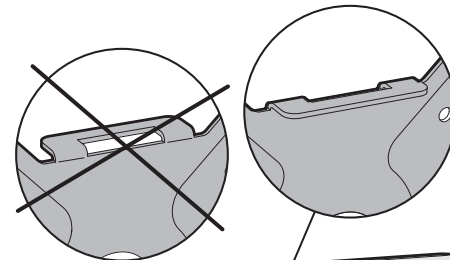

②

