

TRV100

VIDEO CONFERENCING TROLLEY
WÓZEK WIDEOKONFERENCYJNY

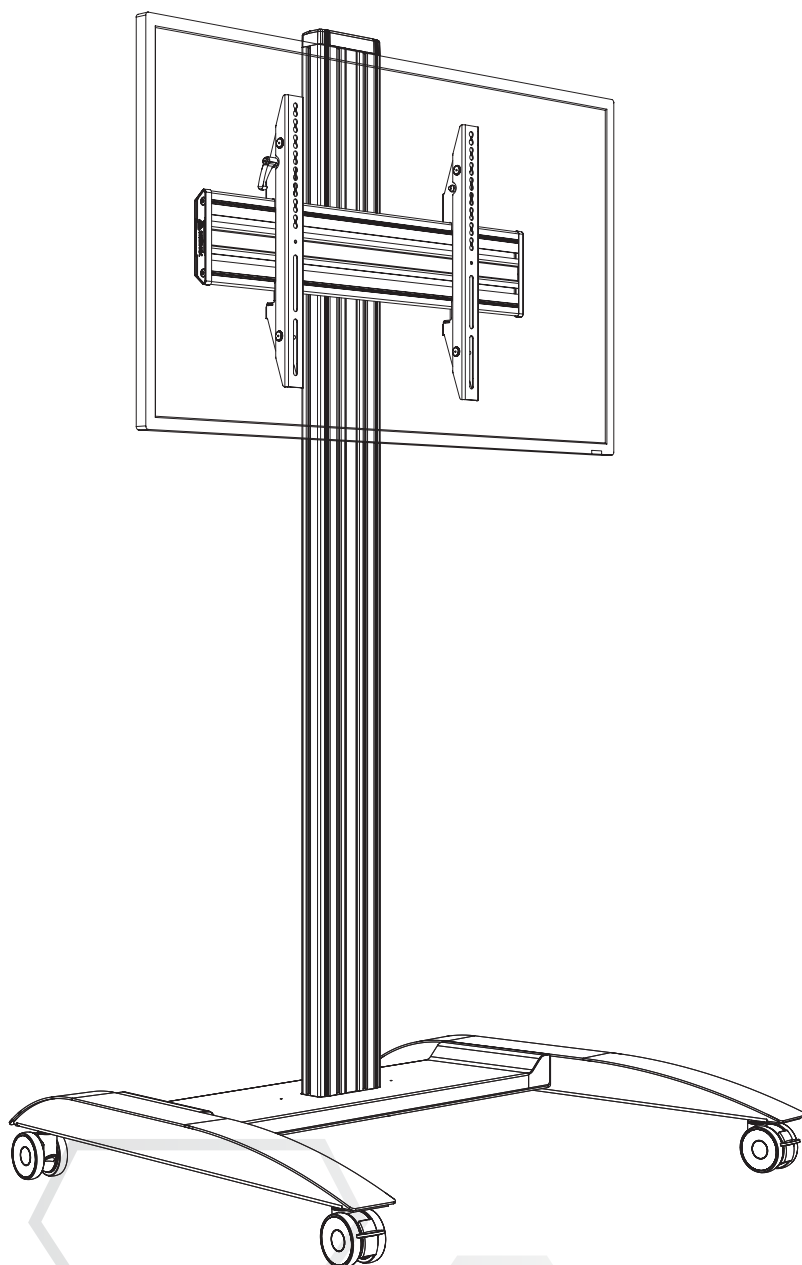

⚠ Warning

Please read this manual before starting the installation to ensure correct assembly. The assembly should be carried out in accordance with this manual by at least two fully qualified people. The EDBAK Company shall not be liable for any injuries or damage to material or property caused by incorrect assembly. Hence please ensure that:

- during the assembly all the instructions are followed carefully. Failure to do so may result in damage to the product or property, or even personal injury;
- before assembly you must ensure that there are no power cables, or water, sewage or gas pipes in the area of the ceiling where the mount is to be fixed;
- when attaching the projector to the mount, please ensure that the screws are of the correct length and diameter. In order to ensure the correct fit, use the plastic spacers supplied. Use of the wrong screws may result in permanent product damage. Extra caution should be taken with movable parts in order to avoid crushing or pinching your hands or fingers. The movable parts are identified in this manual.

The terms of the product guarantee are detailed in the guarantee card.

⚠ Ostrzeżenie

Przed rozpoczęciem montażu należy uważnie zapoznać się z instrukcją uchwytu oraz ekranu w celu zapewnienia prawidłowego montażu.

Prace montażowe powinny wykonywać co najmniej dwie osoby posiadające kwalifikacje w zakresie montażu zgodnie z niniejszą instrukcją. Firma EDBAK nie bierze odpowiedzialności za straty materialne oraz uszkodzenia mienia lub ciała, wynikające z nieprawidłowego montażu. Dlatego należy zawsze przestrzegać:

- w trakcie montażu dokładnie przestrzegać załączonej do produktu instrukcji montażowej, w przeciwnym razie może to prowadzić do zniszczenia sprzętu, a nawet uszkodzeń ciała,
- koniecznie przed montażem upewnić się, że pod powierzchnią ściany, na której będzie mocowany uchwyt nie ma kabli elektrycznych, rur wodnokanalizacyjnych lub instalacji gazowych,
- w trakcie montażu ekranu do uchwytu upewnić się, że użyte śruby są dobrze dobrane co do długości i średnicy. W celu idealnego dobrania długości śrub można skorzystać z dołączonych podkładek plastikowych. Zastosowanie niewłaściwych śrub grozi trwałym uszkodzeniem sprzętu,
- w miejscach wskazanych w instrukcji, w których są ruchome elementy uchwytu zachować szczególną ostrożność w celu uniknięcia przyciśnięcia, dłoni i palców. Warunki gwarancji wg załączonej do produktu karty gwarancyjnej.





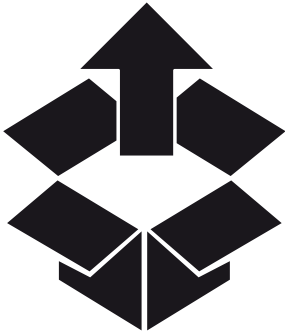









	13mm	II	1x
	8mm	JJ	1x
	8mm	KK	1x
		LL	1x







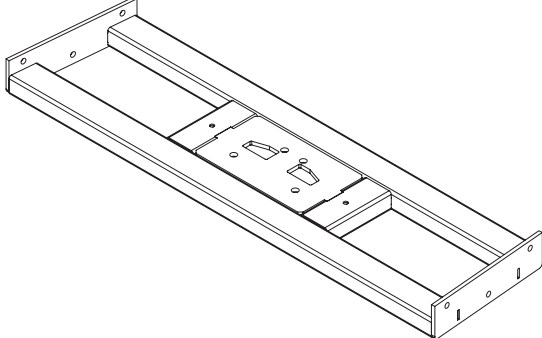
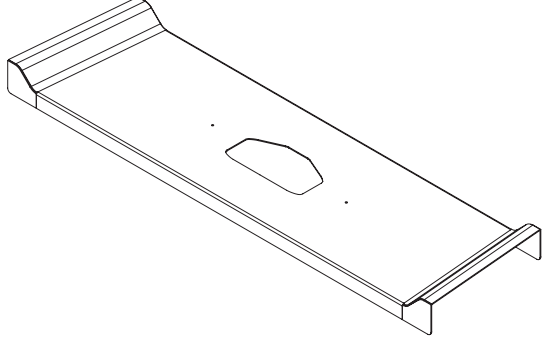
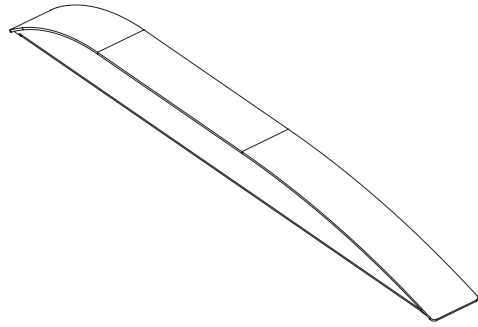
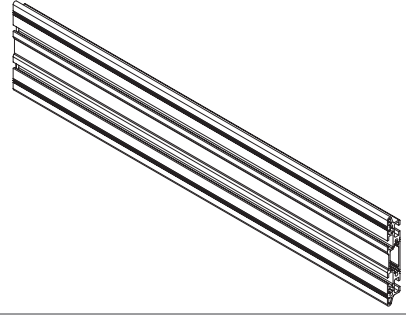
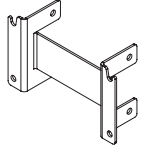

	M8x20	AA	6x
	M5	BB	2x
	8	CC	14x
	S70-10x25	DD	4x
	M10x30	EE	4x
	M8 kanał 10	FF	8x
	M8x16	GG	8x
	M6x16	HH	4x

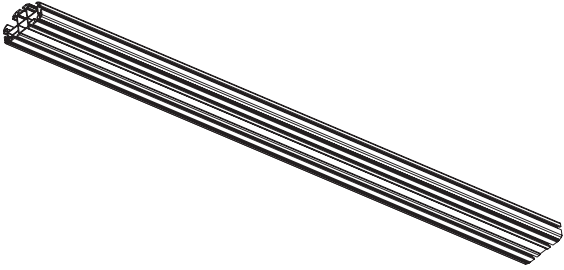

	M4 x 20	A01	4x
	M5 x 20	A02	4x
	M5 x 20	A03	4x
	M8 x 20	A04	4x
	fi15 x fi8,4 x 5	A05	4x
	fi15 x fi8,4 x 10	A06	4x
	M8	A07	4x
	M5 x fi14	A08	4x
	3mm	A09	1x
	4mm	A10	1x
	5mm	A11	1x
	6mm	A12	1x

	A	1x
	B	1x
	C	2x
	D	1x
	E	1x

	<p>F</p>	<p>1x</p>
	<p>G</p>	<p>2x</p>
	<p>I</p>	<p>1x</p>
	<p>H</p>	<p>1x</p>
	<p>J</p>	<p>2x</p>
	<p>K</p>	<p>2x</p>
	<p>L</p>	<p>2x</p>

1.

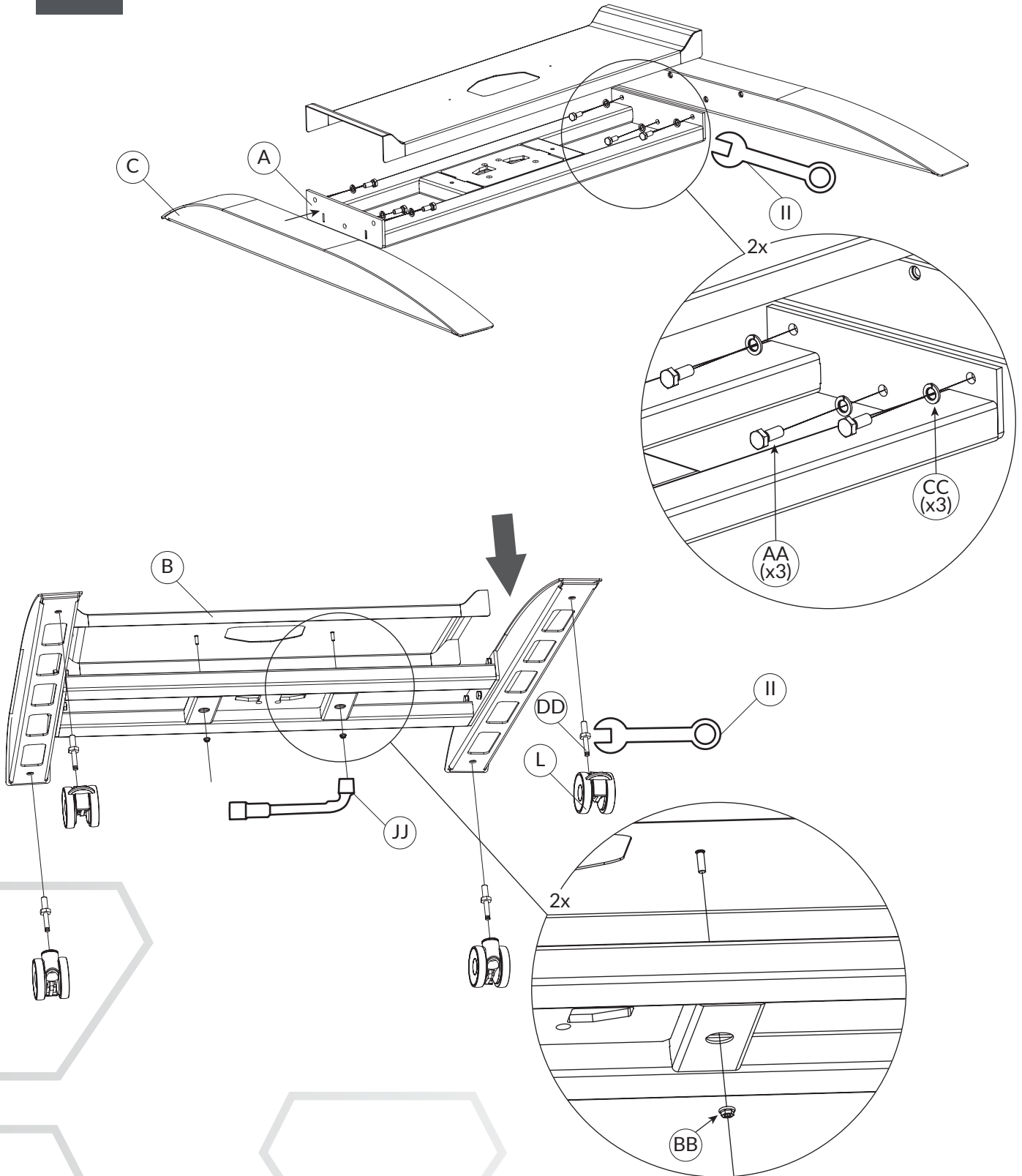

2.

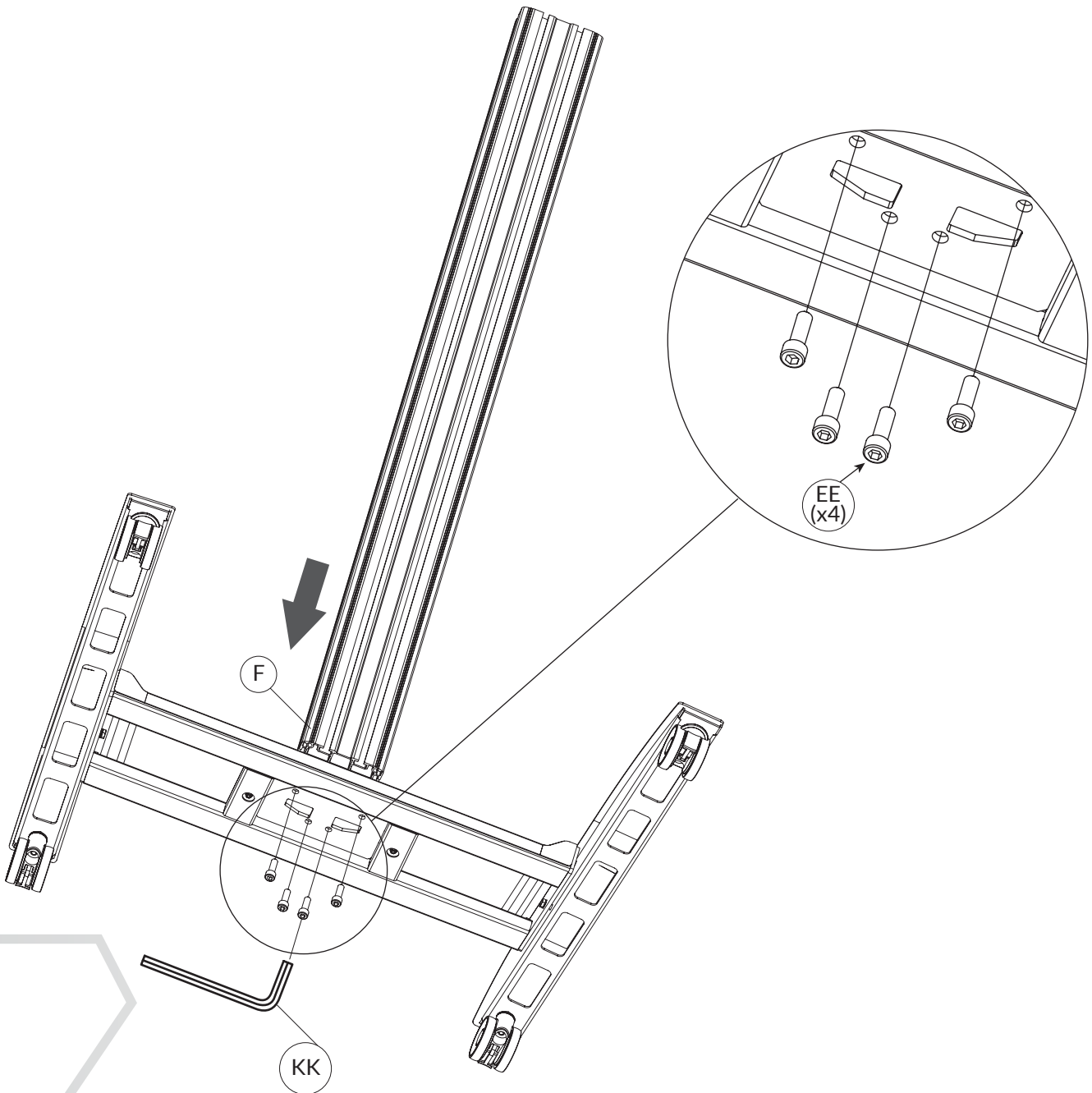

3.

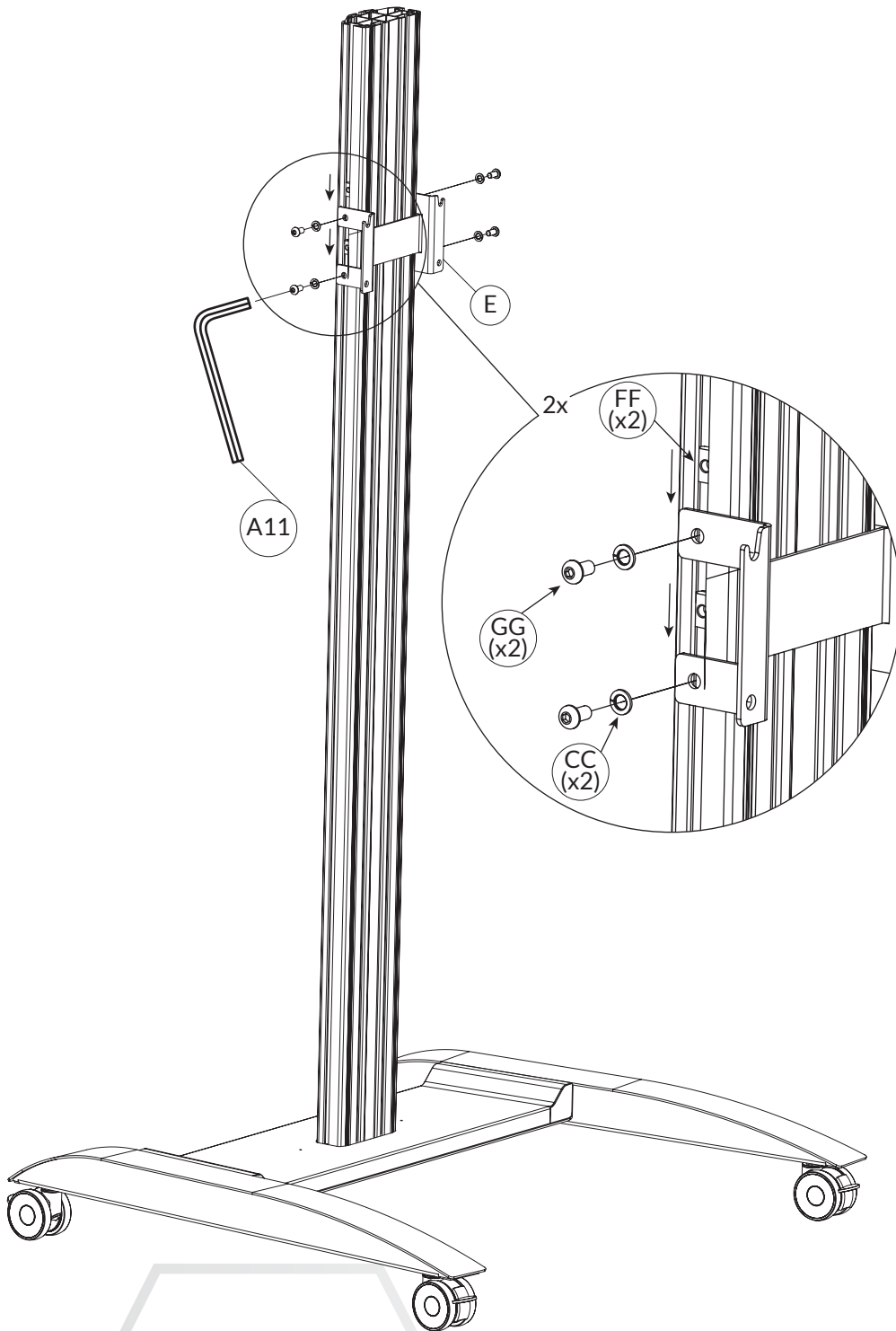

4.

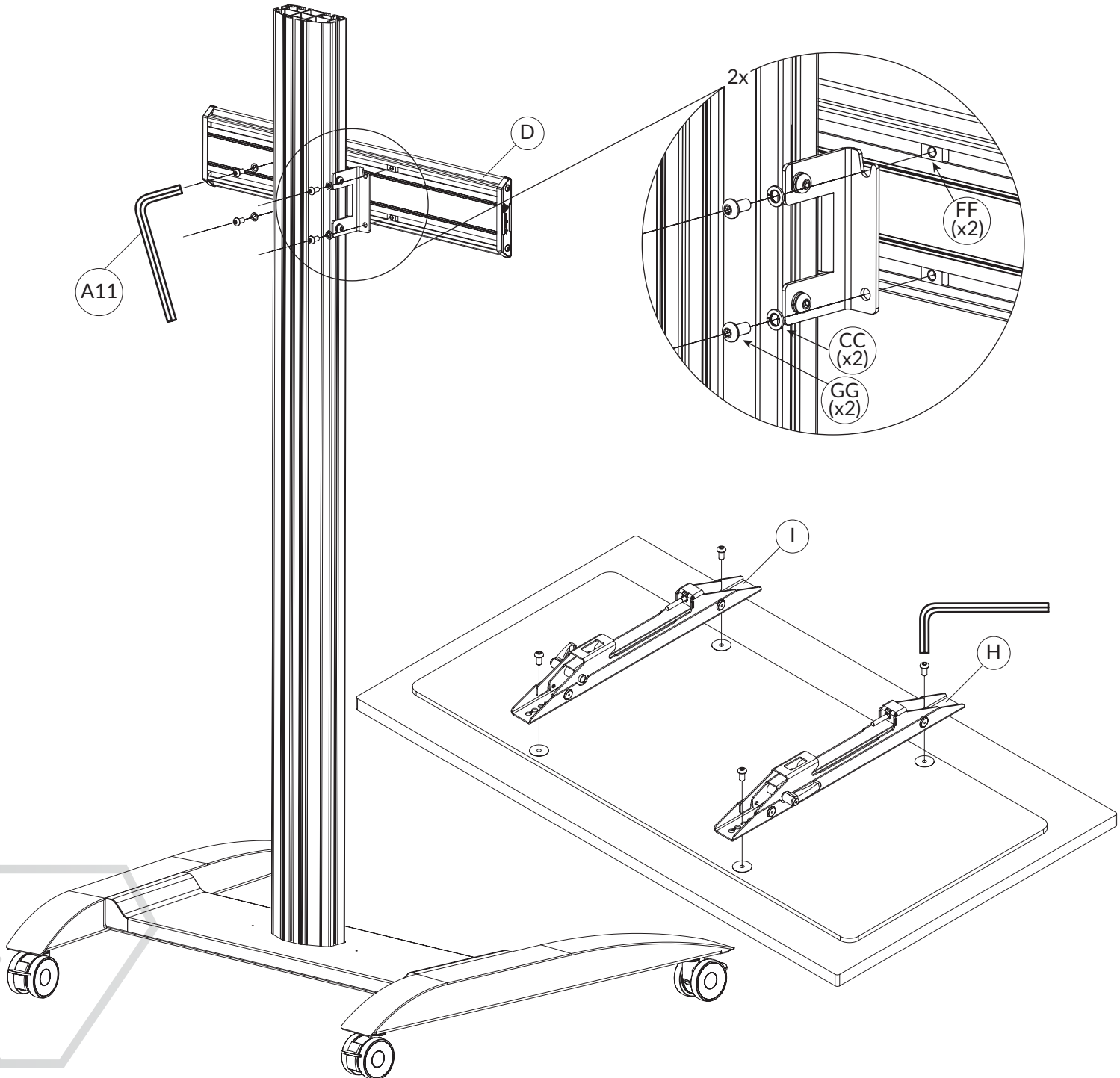

5.

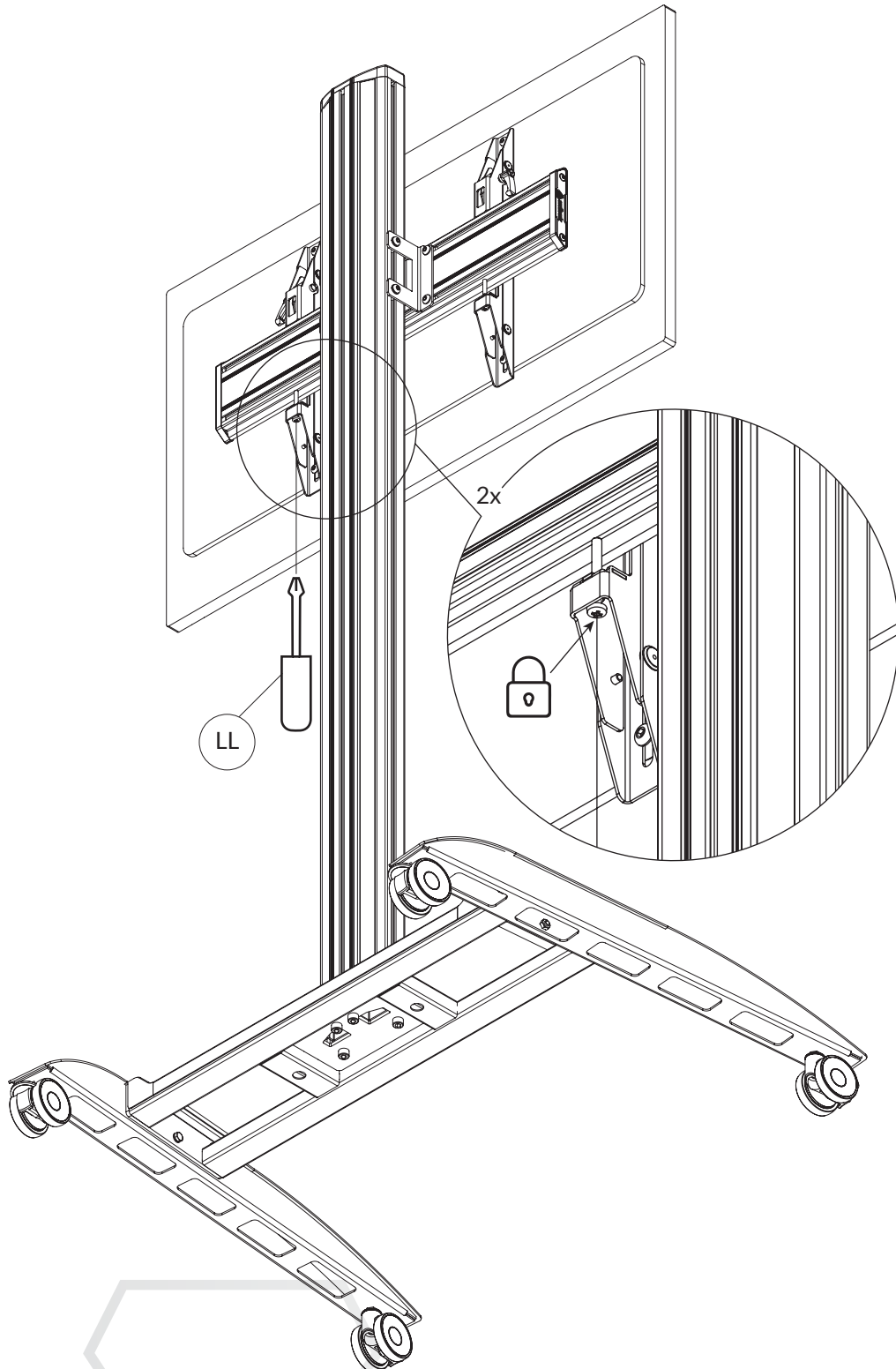

6.

