

# Ergotron® LX

## Dual Stacking Arm

### Dimensional & Range of Motion Illustrations

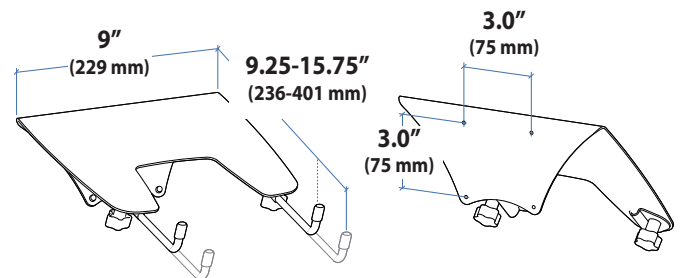
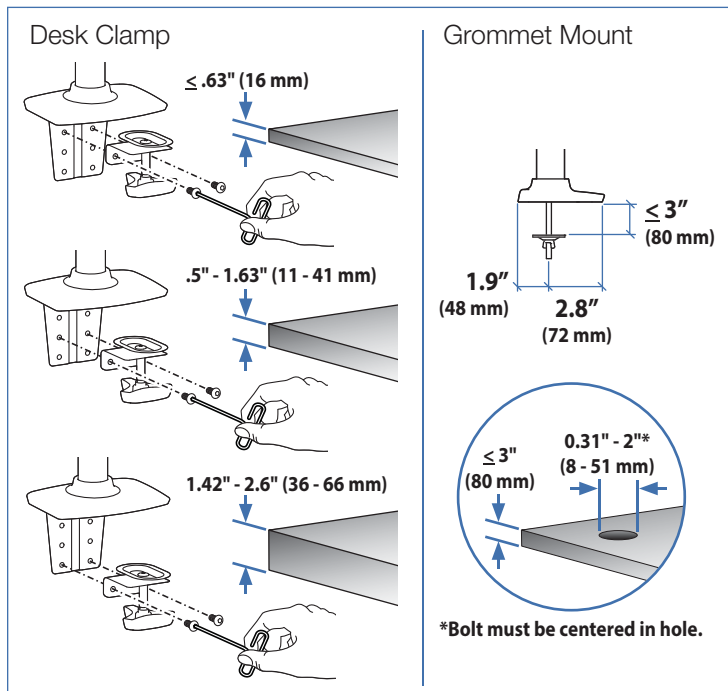
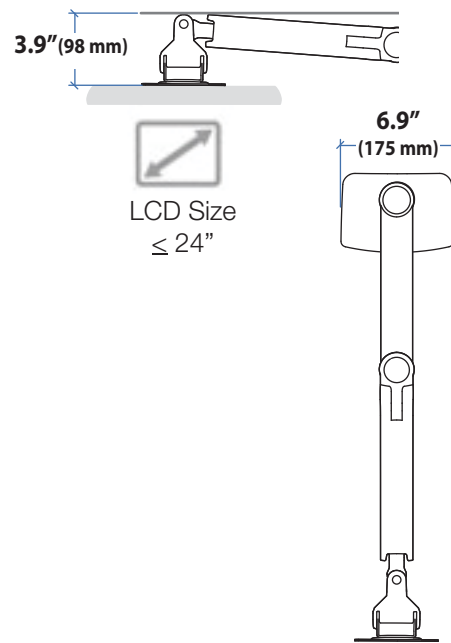
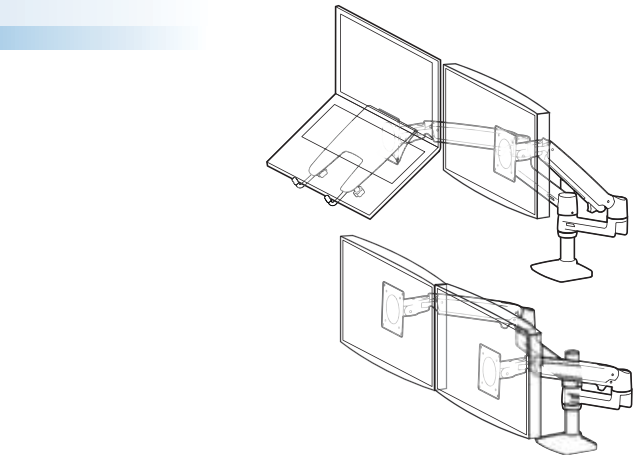
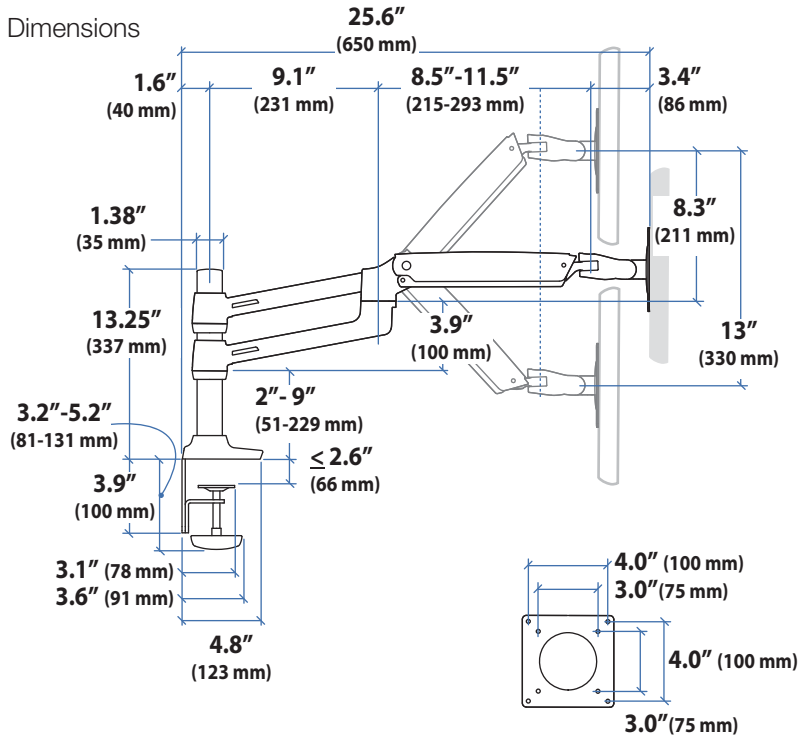

© 2014 Ergotron, Inc. rev. 07/28/2014 DIM2-062 Content is subject to change without notification

**Americas Sales and Corporate Headquarters**  
 St. Paul, MN USA  
 (800) 888-8458  
 +1-651-681-7600  
 www.ergotron.com  
 sales@ergotron.com

**EMEA Sales**  
 Amersfoort, The Netherlands  
 +31 33 45 45 600  
 www.ergotron.com  
 info.eu@ergotron.com

**APAC Sale**  
 Tokyo, Japan  
 www.ergotron.com  
 apaccustomerservice@ergotron.com

**Worldwide OEM Sales**  
 www.ergotron.com  
 info.oem@ergotron.com



# Ergotron® LX

## Dual Stacking Arm

### Dimensional & Range of Motion Illustrations

#### Range of Motion

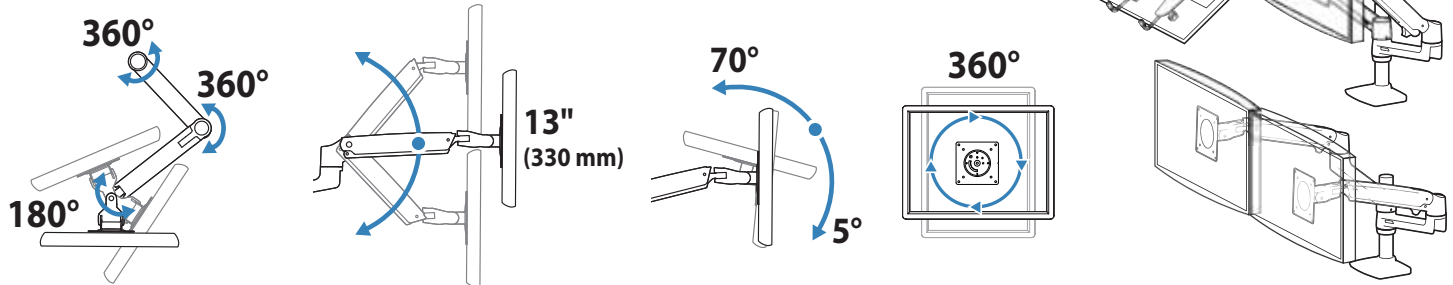

#### Weight Capacity

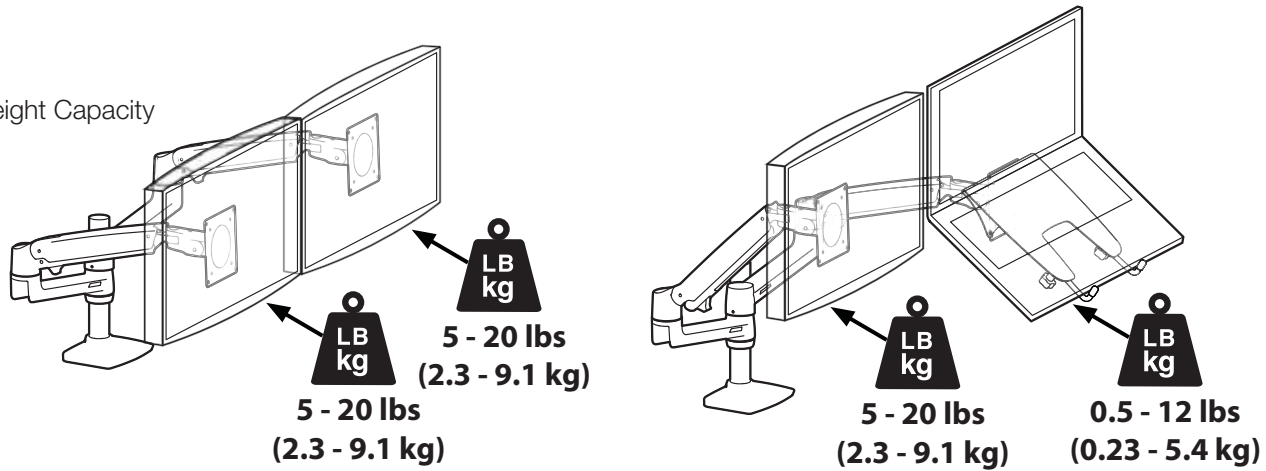

Monitor depth greater than 2.5" (64 mm) may diminish capacity. Call Ergotron for more information.

© 2014 Ergotron, Inc. rev. 07/28/2014 DIM2-062 Content is subject to change without notification

#### Americas Sales and Corporate Headquarters

St. Paul, MN USA  
(800) 888-8458  
+1-651-681-7600  
www.ergotron.com  
sales@ergotron.com

#### EMEA Sales

Amersfoort, The Netherlands  
+31 33 45 45 600  
www.ergotron.com  
info.eu@ergotron.com

#### APAC Sale

Tokyo, Japan  
www.ergotron.com  
apaccustomerservice@ergotron.com

#### Worldwide OEM Sales

www.ergotron.com  
info.oem@ergotron.com

